

Marshmallow Challenge

Taken from www.marshmallowchallenge.com

Objective: Students will be able to build a freestanding structure with a marshmallow on top.

Team Members: 2-4

Time Frame: 45-60 minutes

Materials:

- Uncooked spaghetti. Angel hair is too thin, linguini too thick. (20 per group)
- String. (1 yard per group)
- Masking Tape (1 yard per group)
- Paper Lunch Bags (1 per group)
- Measuring Tape
- Stopwatch (www.onlinestopwatch.com is a great resource)

Procedures:

Rules: Students are to build a freestanding tower out of the materials in the bag in 18 minutes

- The structure must be free standing. It cannot be suspended from a higher structure like a chair, ceiling, or chandelier.
- The entire marshmallow must be on top. Cutting or eating the marshmallow disqualifies the team.
- Use as much or little of the kit. Teams may use as many or as few of the 20 pieces of spaghetti, as much or as little of the tape or string. The team cannot use the paper bag as part of their structure.
- You may break the spaghetti, string, and tape.
- Teams cannot hold the structure when the time runs out. Those touching or supporting the structure will be disqualified. The winning structure must be stable.

Pre-Activity: Make the paper bag kits. The tape tends to stick to itself. It is suggested that the tape is ready for the teams to grab when the kits are passed out or you walk around giving the teams the tape.

Intro: Tell the students that today they will be building a tower. Divide them into groups. Explain the rules of the challenge and ask if there are any questions. Make sure that all of the students know what the goal is and what the rules are.

Activity: Pass out the materials and start the clock. Walk around the room. Point out when a team has built a structure. Encourage teams to look around the room and see how other teams

are doing. Let the group know how much time is left (i.e. 15 minutes, 5 minutes, etc). Do a 30 seconds countdown. When the time is over, tell the groups to sit down and look around the room. Make sure no one is touching their structure. Measure each structure and announce the winner. If you are offering a prize, hand out the prize.

Closure: Explain that the students just went through the Engineering Design Process. Have the winning team describe what they did to make their structure. Ask each group what they would do differently if they could do it again. This challenge has the lesson that prototyping matters. Kids tend to do better than adults because they play with the materials to make the structure while adults plan it out. Emphasize that, as they are working on their projects, students should make prototypes and try out their ideas.

MESA Lesson Activity

Suggested Sequence of Activities	<ul style="list-style-type: none"> • Float Your Boat (20-25 minutes) • MESA Student Policies and Procedures (30-35 minutes)
Duration	60-75 minutes
Age Level	Middle School
Essential Question	How does the modification of clay affect whether it floats in water?
Learning Objectives	<p>Float Your Boat</p> <ul style="list-style-type: none"> • TSW compare the floatation abilities of different clay shapes • TSW explain why modifying the shape of modeling clay allows it to float • TSW manipulate the shape of their clay so that it does float in water • TSW hypothesize the reason for a structure's ability to float and apply their reasoning to their own clay model • TSW deduce that more surface area allows the water molecules to push against the surface of the clay that allows it to float • TSW deduce that clay spread over more surface area displaces more water that allows it to float • TSW communicate the results of the activity to their peers
Other Objectives	<ul style="list-style-type: none"> • TSW develop a working plan with their group to develop a cooperative environment • TSW communicate with their group by contributing their vocal input
Key Terms	<ul style="list-style-type: none"> • Hypothesis • Modify • Surface area • Molecules and Water Molecules (optional)
Materials Needed	<p>Float Your Boat:</p> <ul style="list-style-type: none"> • Chunk of clay for demonstration • Large bowl or tub of water • Marbles • Paper Towel <p>Per Group of 2 students</p> <ul style="list-style-type: none"> • Modeling Clay- 1" square or 50g • Engineer's Notebook Handout <p>MESA Policies and Procedures:</p> <ul style="list-style-type: none"> • Student Policies and Procedures Handout
Lead In	<p>Math Problem:</p> <ol style="list-style-type: none"> 1. Pass math problem out to students as they arrive for MESA meeting. Remind them to sign in on attendance sheet. 2. Inform students that they may work individually or in groups of 2. Instruct them not to give the answer if they solve it before time is up. 3. Monitor and guide students to the solution. 4. After 10-15 minutes, have one student model each problem on the board to explain how they arrived at their answer. Discuss alternate methods of problem solving with students. 5. Collect Engineer's Notebook handout from previous meeting and discuss. Students may wish to share their sketches.
Activity	<p>Float Your Boat:</p> <ol style="list-style-type: none"> 1. Pass out Engineer's Notebook handout. 2. Direct student's attention to teacher demonstration. 3. Hold up a ball of modeling clay. 4. Ask, "When I drop this in the water, who thinks it will float? (pause and wait for responses) Who thinks it will sink? (Pause and wait for responses)"

	<ol style="list-style-type: none"> 5. Ask students to defend and explain their predictions. 6. Write the term 'hypothesis' on the board and Instruct students to write it in the 'key term' section of their Engineer's Notebook handout. 7. Ask, "What is a hypothesis?" Most students will know, guide them to a class definition and put it on the board. Have students write the class definition on their handout. 8. Apply the definition to the hypothesis they just made about whether or not the ball of clay will float. 9. Drop clay into the water. (Clay should sink) 10. Ask students, "What can I do to this clay to try to make it float?" Solicit answers and discuss. Students will make the same suggestions such as flatten it out, make it thin, make sure there are walls on the edges so water doesn't get in... 11. Write the term 'modify' on the board and instruct students to write the term in the 'key term' section of their handout. Ask one student to look up the definition in a dictionary. The general definition is 'to change'. This simple definition can be used as the student definition. 12. Now ask, "How can I modify this clay to try to make it float?" Students will make the same suggestions such as flatten it out, make it thin, make sure there are walls on the edges so water doesn't get in... 13. Point out that 'to modify' something is 'to change it' so it works better. 14. Use student suggestions to guide them to a communal understanding that the more spread out the clay is, the better chance it has of floating. 15. Write the term 'surface area' on the board. Ask students to come up with a definition of the term on their own using word recognition strategies. Guide students by using other objects in the room that have large surface areas. Many will already know what surface area is. Write a communal definition on the board and have them copy it on their handout. 16. Review how their suggestions of spreading the clay out will give the clay a better chance of floating because of the increase in surface area. 17. Ask, "When my clay boat floats, what is keeping it from sinking?" Student suggestions will vary. You can help them by asking, "To keep something from going down, something has to push it up. What could be pushing up against my boat to keep it from going down?" Guide students so they understand that the water is pushing up against the boat. 18. Review how surface area spreads the clay out, now guide students to understand that the more surface area there it, the more areas there are for water to push up against. You may introduce water molecules here. 19. Tell students that they are to use the concepts of 'modifying' and 'surface area' to design and mold a chunk of clay into a boat that can float. Their boat has to float and hold a minimum of 5 marbles. 20. Pass out the clay and allow students 5 minutes to come up with a boat. <i>Remind students to write the materials in the 'materials used' section of the Engineer's Notebook.</i> 21. Have them test it. 22. Give them another 5 minutes to modify their design. 23. Test all the boats.
<p>Closure</p>	<ol style="list-style-type: none"> 1. Ask students to hold up their boats and explain how their team arrived at the final design. 2. Ask students to describe any problems they had in designing and constructing their boat. 3. Ask students to describe what they would change to make their boat better if they had more time. 4. Instruct students to complete the 'procedure' section of the Engineer's Notebook. It should be a sequential description of their team's design and

	<p>construction of their boat.</p> <p>5. Instruct students to answer the following question in the 'conclusion' section of the Engineer's Notebook: How does the modification of clay affect whether it floats or not?</p> <p><i>*Note: Students may complete the 'Procedure' and 'Conclusion' section of the Engineer's notebook at home before the next MESA meeting if time is an issue.</i></p> <p>MESA Student Policies and Procedures</p> <ol style="list-style-type: none"> 1. Review MESA Mission and MESA Calendar. Answer questions they may have. 2. Pass out handouts that give Student Policies and Procedures Overview. 3. Go over what is expected of students and your role in helping them successfully achieve these expectations. 4. Discuss and answer questions. 						
Informal Assessment	<ul style="list-style-type: none"> • Monitor students to check for understanding • Monitor students to check for participation • Student oral presentation explaining their team's procedure 						
Formal Assessment	<ul style="list-style-type: none"> • Completed Clay Boat • Completed Engineer's Notebook Handout (They may complete this before the next MESA meeting) 						
Trouble Shooting	<ul style="list-style-type: none"> • Keep an eye on the time. Don't linger too long over a single component or you will run out of time. • Make sure all students participate in clean up. • Before lesson, fill bowl/tub with water. • Keep an eye on the marbles. 						
SEI Strategies Used							
<table border="0"> <tr> <td> Preparation <input type="checkbox"/> Adaptation of Content <input type="checkbox"/> Links to Background <input type="checkbox"/> Links to Past Learning <input checked="" type="checkbox"/> Strategies incorporated </td> <td> Scaffolding <input type="checkbox"/> Modeling <input checked="" type="checkbox"/> Guided practice <input type="checkbox"/> Independent practice <input checked="" type="checkbox"/> Comprehensible input </td> <td> Grouping Options <input type="checkbox"/> Whole class <input type="checkbox"/> Small groups <input checked="" type="checkbox"/> Partners <input type="checkbox"/> Independent </td> </tr> <tr> <td> Integration of Processes <input type="checkbox"/> Reading <input checked="" type="checkbox"/> Writing <input checked="" type="checkbox"/> Speaking <input checked="" type="checkbox"/> Listening </td> <td> Application <input checked="" type="checkbox"/> Hands-on <input checked="" type="checkbox"/> Meaningful <input checked="" type="checkbox"/> Linked to objectives <input checked="" type="checkbox"/> Promotes engagement </td> <td> Assessment <input type="checkbox"/> Individual <input checked="" type="checkbox"/> Group <input checked="" type="checkbox"/> Written <input checked="" type="checkbox"/> Oral </td> </tr> </table>		Preparation <input type="checkbox"/> Adaptation of Content <input type="checkbox"/> Links to Background <input type="checkbox"/> Links to Past Learning <input checked="" type="checkbox"/> Strategies incorporated	Scaffolding <input type="checkbox"/> Modeling <input checked="" type="checkbox"/> Guided practice <input type="checkbox"/> Independent practice <input checked="" type="checkbox"/> Comprehensible input	Grouping Options <input type="checkbox"/> Whole class <input type="checkbox"/> Small groups <input checked="" type="checkbox"/> Partners <input type="checkbox"/> Independent	Integration of Processes <input type="checkbox"/> Reading <input checked="" type="checkbox"/> Writing <input checked="" type="checkbox"/> Speaking <input checked="" type="checkbox"/> Listening	Application <input checked="" type="checkbox"/> Hands-on <input checked="" type="checkbox"/> Meaningful <input checked="" type="checkbox"/> Linked to objectives <input checked="" type="checkbox"/> Promotes engagement	Assessment <input type="checkbox"/> Individual <input checked="" type="checkbox"/> Group <input checked="" type="checkbox"/> Written <input checked="" type="checkbox"/> Oral
Preparation <input type="checkbox"/> Adaptation of Content <input type="checkbox"/> Links to Background <input type="checkbox"/> Links to Past Learning <input checked="" type="checkbox"/> Strategies incorporated	Scaffolding <input type="checkbox"/> Modeling <input checked="" type="checkbox"/> Guided practice <input type="checkbox"/> Independent practice <input checked="" type="checkbox"/> Comprehensible input	Grouping Options <input type="checkbox"/> Whole class <input type="checkbox"/> Small groups <input checked="" type="checkbox"/> Partners <input type="checkbox"/> Independent					
Integration of Processes <input type="checkbox"/> Reading <input checked="" type="checkbox"/> Writing <input checked="" type="checkbox"/> Speaking <input checked="" type="checkbox"/> Listening	Application <input checked="" type="checkbox"/> Hands-on <input checked="" type="checkbox"/> Meaningful <input checked="" type="checkbox"/> Linked to objectives <input checked="" type="checkbox"/> Promotes engagement	Assessment <input type="checkbox"/> Individual <input checked="" type="checkbox"/> Group <input checked="" type="checkbox"/> Written <input checked="" type="checkbox"/> Oral					
Arizona Math Standards Addressed	<ul style="list-style-type: none"> • S1C2: TSW understand and apply numerical operations and their relationship to one another by solving word problems using grade-level appropriate operations and numbers. • S4C4: TSW understand and apply appropriate units of measure, measurement techniques, and formulas to determine measurement. Specifically, to distinguish between perimeter and area in given contextual situation. 						
Arizona Science Standards Addressed	<ul style="list-style-type: none"> • S1C1: TSW formulate predictions and questions based on observations. • S1C2: TSW design a controlled investigation and keep a record of their observations, notes, and sketches. • S1C4: TSW communicate the results of their investigation and create a list of instructions that others can follow. • S2C2: TSW understand how science is a process for generating knowledge and apply scientific processes to problem solving situations. 						

Paper Airplane – Accuracy

Objective: Students will be able to build paper airplanes that will hit a target.

Team Members: 2

Approximate Total Time: 30 minutes

Materials:

- 8.5 by 11 inch printer paper (1 ream)
- Ruler (1 per group)
- Target – See **Target** section for ideas

Rules:

1. Students will have 20 minutes to research, construct, and test their airplane prior to judging.
2. Airplane must be constructed from materials provided. No other materials will be allowed.
3. The airplane must have a wing-like surface of at least 10 cm³.
4. Students will stand 3 meters (approximately 10 feet) from target to throw

Resources:

All types of airplanes: <http://www.foldnfly.com/>

15 designs of airplanes: <http://www.funpaperairplanes.com/>

Target:

The target can be as varied as your classroom. Some ideas are:

- Target on whiteboard
- Target made of poster board
- Hula hoop
- Box

Any target is fine as long as it is clearly defined.

Procedures:

Intro: Every kid knows paper airplanes. Today, we are going to be building a plane with a specific purpose. We want to design and build a plane that will hit a specified target.

Activity: Divide the students into groups of 2. Give each group a ruler. Tell them that they will have 20 minutes to research, design, build, and test the plane that they think will fly hit the target. Give each group 2 pieces of paper to start. Start the timer.

Note: If a group needs more paper, let them have it. One of the goals is to let the students explore the different styles of planes that will allow them to reach their goal.

When the 20 minutes have expired, end the building and take the students to a pre-set launch point. Have each group throw their design and measure the distance. The group that hits the target closest to the “bull’s eye” is the winner. In the event of a tie, have groups re-throw their planes.

Closure: Talk to students about their design and research. Did the results go as expected? Were there any variables that they didn't account for? Could they re-create their results with another copy of their plane?

Try to tailor the discussion to be about the build process and how it can vary from iteration to iteration. Even though the students had resources for their design, the results of the different planes can vary a lot. Tell students that their MESA projects want to have a predictable set of results and we want to eliminate as many variables as we can.

Paper Airplane – Distance

Objective: Students will be able to make a paper airplane that will fly the farthest.

Team Members: 2

Approximate Total Time: 30 minutes

Materials:

- 8.5 by 11 inch printer paper (1 ream)
- Ruler (1 per group)
- Tape measure or similar measuring device

Rules:

1. Students will have 20 minutes to research, construct, and test their airplane prior to judging.
2. Airplane must be constructed from materials provided. No other materials will be allowed.
3. The airplane must have a wing-like surface of at least 10 cm³.
4. Distance will be measured as the distance from the launch point to the tip of the nose perpendicular from the launch point (i.e. in a straight line)

Resources:

All types of airplanes: <http://www.foldnfly.com/>

15 designs of airplanes: <http://www.funpaperairplanes.com/>

Procedures:

Intro: Every kid knows paper airplanes. Today, we are going to be building a plane with a specific purpose. We want to design and build a plane that will travel the furthest.

Activity: Divide the students into groups of 2. Give each group a ruler. Tell them that they will have 20 minutes to research, design, build, and test the plane that they think will fly the furthest. Give each group 2 pieces of paper to start. Start the timer.

Note: If a group needs more paper, let them have it. One of the goals is to let the students explore the different styles of planes that will allow them to reach their goal.

When the 20 minutes have expired, end the building and take the students to a pre-set launch point. Have each group throw their design and measure the distance. Largest distance is the winner.

Closure: Talk to students about their design and research. Did the results go as expected? Were there any variables that they didn't account for? Could they re-create their results with another copy of their plane?

Try to tailor the discussion to be about the build process and how it can vary from iteration to iteration. Even though the students had resources for their design, the results of the different planes can vary a

lot. Tell students that their MESA projects want to have a predictable set of results and we want to eliminate as many variables as we can.

Extension: Have students build the same model 5 times and predict the results. Have students test in the same way and check the accuracy of their predictions.

Paper Helicopters

Objective: Students will build a paper helicopter to hit a designated target when dropped from a specific height.

Team Members: 2-4

Materials:

- 8.5 by 11" printer paper (1 ream)
- Paper clips
- Scissors
- Ladder or launching point at least 10 feet above the ground.

Time Frame: 30-40 minutes

Procedure:

Pre-Activity:

Create copies of the directions on the following page on how to make a paper helicopter. Or, you can project the directions. The goal of the activity is to have students make a pre-designed helicopter and talk about the variation of design even when everyone is following the same directions.

Have your space set up for the target. The target should be a circle of radius $1/2$ foot.

Intro:

Tell students that today they are going to see build helicopters to hit a target. Explain that you will be giving them the design for the helicopter that they will need to construct. Tell them that they will have 20 minutes to build their designs. Pass out the materials.

Activity:

Give students the directions and have them build their helicopters. Monitor the room to make sure that the students are following the directions. All teams must be using the same directions. When the 20 minutes is complete, have them stop building. Have each group hand you their design one at a time and you drop the helicopter. This will ensure consistency in how they are released. Have students time the drops and check the accuracy of the helicopters.

Closure:

Talk with students about the results. They will probably be varied. See if students can come up with reasons why the results were different. Talk about the importance of consistency in

construction. Talk about human error in construction of prototypes and the importance of testing your designs.

PROCEDURE:

1. Draw a line in middle of paper. Divide bottom half into thirds
2. Cut along midway line on both outside thirds. Fold in these flaps.
3. Fold small section up on flaps. Attach a paperclip here to keep it folded
4. Draw a line $\frac{2}{3}$'s the way down in top half of paper.
5. Cut the paper in half down to the $\frac{2}{3}$ line. Fold down to create helicopter blade
6. Drop helicopter and monitor the time it takes to reach ground

DIAGRAM:

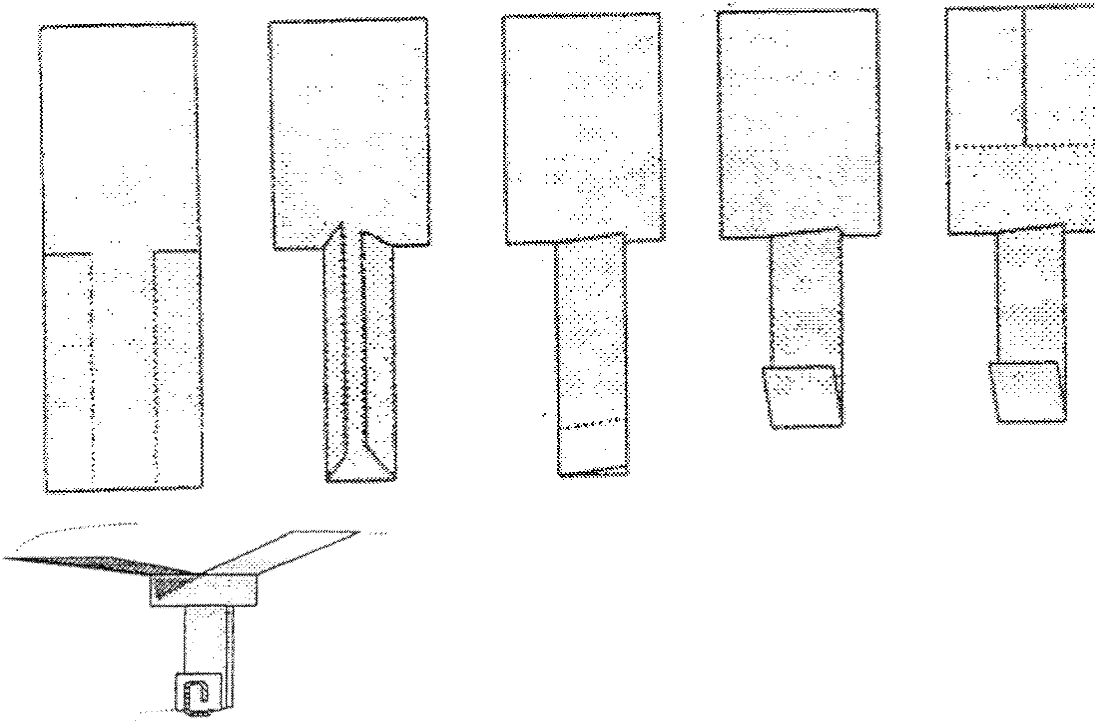

Paper Tower Contest

Objective: Students will be able to build the tallest free-standing tower possible from a single sheet of paper within 30 minutes

Team Member: 2-4

Approximate Total Time: 60 minutes

Materials:

- One piece of 8.5 by 11 in paper per group
- Scotch Tape
- Scissors
- Ruler
- Pencil

Rules:

1. Each tower must be made only out of paper and tape. No other materials or substitutions are allowed.
2. Each tower must be free-standing. It cannot be attached to the floor or attached to or leaning against any other surface (i.e wall, desk, etc.)
3. Students will have 30 minutes to construct a tower. Any changes made after the 45 minutes has expired will disqualify the students.

Procedures:

Intro: Divide students into groups. Tell students that they will be doing a civil engineering type activity. Explain problem and distribute materials. Set timer and begin. A great resource is <http://www.online-stopwatch.com/> It has a countdown timer that can be set. This way students can see how much time is remaining.

Activity: Allow students to work in their groups. Let the students work to build their towers. At the end of the 30 minutes, tell students to stop working. Measure the height of the tower from the base to the highest vertical point.

Closure: Ask students to explain their design. Ask students to identify what worked and what didn't work. If they were to make any changes, what would they do?

Explain that they have just informally completed the Engineering Design Process. The students explored the problem, designed and built their solution, and then tested it. The questions at the end lead them back through the cycle by having them explore their solutions and decide the strong pieces and the pieces that they noticed failed.



Grade Level:
Grades 5 - 12

Activity Time:
30 minutes

Preparation Time:
15 minutes

Grouping:
Pairs



*Adapted from
<http://www.eweek.org/2002/discover/activities/archive.shtml>

Radioactive Golf Balls

Objectives:

- To work in teams to solve a problem
- To work within a very tight deadline

Materials:

For each group of students, you will need:

- | | |
|---|----------------------|
| 1) 2 brown paper lunch bags | 4) 4 drinking straws |
| 2) 5 golf balls (placed inside one of the paper bags) | 5) 2 skewers |
| 3) 4 4" pieces of string | 6) 4 paper clips |
| | 7) 4 rubber bands |
| | 8) 5 Post-It notes |
| | 9) 3 push pins |
| | 10) 1 pencil |
| | 11) 1' tape |

To test the devices, you will need:

- | | |
|-----------------|--------------|
| 1) Tape measure | 2) Stopwatch |
|-----------------|--------------|

Directions:

1. Break the class into teams of 2 and hand them their materials.
2. Tell the group that the golf balls are radioactive and the object of the game is to move all the golf balls from one paper bag to the other without touching the golf balls or tilting their bag.
3. Each group has 20 minutes to construct a device that can transport 1 golf ball at a time using only the supplies provided. The teams may alter the supplies in any way necessary.
4. Place both bag #1 and bag #2 on the floor approximately 8 feet apart. The bags are to sit on the ground with the opening toward the ceiling. To ensure that the bags do not move tape both bags to the floor.
5. No part of a person's body or clothing may touch the golf balls. If a person touches a ball, or if a ball gets dropped, there is a contamination leak! The leader (you) must return the contaminated ball back to bag #1.
6. The team that moves all their balls in the shortest amount of time wins.
7. Have a discussion on the differences of each team's device. Which device was successful? Which ones weren't, and why? Did having a time limit affect their end product? At the end, make sure to point out that there is no single way to get the task done - there are many methods that will work.

Straw Tower Contest

Objective: Students will be able to build the tallest free-standing tower possible from drinking straws and marshmallows in 30 minutes.

Team Member: 2-4

Approximate Total Time: 45 minutes

Materials:

- 50 drinking straight drinking straws per group
- 50 mini marshmallows per group
- 1 Large marshmallow per group

Rules:

1. The tower must be constructed using as many of the straws and marshmallows that a team chooses to use but does not exceed the number supplied. No other materials or substitutions are allowed.
2. Straws may be bent or fitted inside one another, but they may not be cut.
3. The tower must be free-standing. It must not touch, be attached to, or be leaning against any other surface (i.e. walls, ceiling, desk, etc)
4. Students will have 30 minutes to build a tower from scratch.
5. Marshmallows may not be moistened.

Procedures:

Intro: Divide students into groups. Tell students that they will be doing a civil engineering type activity. Explain problem and distribute materials. Set timer and begin. A great resource is <http://www.online-stopwatch.com/> It has a countdown timer that can be set. This way students can see how much time is remaining.

Activity: Allow students to work in their groups. Let the students work to build their towers. At the end of the 30 minutes, tell students to stop working. Measure the height of the tower from the base to the highest vertical point.

Closure: Ask students to explain their design. Ask students to identify what worked and what didn't work. If they were to make any changes, what would they do?

Explain that they have just informally completed the Engineering Design Process. The students explored the problem, designed and built their solution, and then tested it. The questions at the end lead them back through the cycle by having them explore their solutions and decide the strong pieces and the pieces that they noticed failed.

CHEMICAL ENGINEERING AND MANUFACTURING

CHEMICAL ENGINEERING

Objective

Chemical Engineers are involved in the production of food, cosmetics, fuels, and anything else that requires the mixing of chemicals. This lesson introduces students to one component of chemical engineering: food processing.

Learning Outcomes

Students will learn:

1. The difference between a food scientist, a chemist, and a chemical engineer
2. How chemical engineers are involved in food production
3. That chemical engineers need math to change a simple chemical equation or recipe into mass production

Essential Questions

1. How do they make 4 billion Pop Tarts in a year?
2. Why do Fruit Loops taste the same no matter where you are?
3. How are chemical engineers involved with food processing?

Time Required (Itemized)

1. Introduction to Chemical Engineering and activity (20 minutes)
2. Assembly line preparation and competition (30 minutes)
3. Judging of final products (10 minutes)

Assessments

Students may be graded on participation, leadership, completion, attention to detail, etc.

Materials

1. Cookies
2. Frosting
3. Food coloring
4. Sprinkles
5. Butcher paper
6. Knives
7. Spoons
8. Cups
9. Paper towels
10. Markers

Lesson Description

Chemical Engineers are responsible for the mass production of many things. They make it so foods taste the same no matter where you are in the world. At Kellogg's, for example, Chemical Engineers work on the filling of Pop Tarts, the pastry, and the frosting.

Questions to ask students:

1. What are the differences in the chemical properties between cake frosting found in a canister and pop tart frosting?
2. Does pop tart frosting burn when you put it in the toaster? Why/Why not?
(Answer: it doesn't burn before the pastry)
3. What would happen if you frosted a pop tart with cake frosting?

If we take a look at the frozen California Pizza Kitchen Pizzas in the freezer section of the grocery store, we can talk about the process. The head chef of California Pizza Kitchen creates a Barbecue Chicken Pizza, then the chef passes the recipe over to the Chemical Engineer to make thousands of the same pizza.

Questions to ask students:

1. How can you take a recipe for one pizza, and increase it to make 50,000 of the exact same pizza? (Answer: chemistry, chemical equations, math, etc.)

There is a branch of Chemical Engineering called Process Engineering. The role of Process Engineers is to create the process used to make things with chemicals on a large scale. This applies to all production: crude oil separation, food processing, cosmetic manufacturing, etc.

Now that students have a background on Chemical Engineers, it is time for the activity. Separate the students into two groups. Each team will work against each other to see who can prepare all of their cookies in the fastest amount of time. The trick is that the cookies need to be uniform, so it's not all about speed.

Procedure:

1. Ask all students to wash their hands and to avoid touching faces, hair, etc.
2. The tables are lined with butcher paper
3. Markers are placed on the tables to determine where the stations will be located
4. Suggested stations
 - a. Cookie start spot
 - b. Cookie finish spot
 - c. Color mixing
 - d. Blue frosting
 - e. Green frosting
 - f. Pink frosting
 - g. Purple frosting
 - h. Sprinkle sorting
 - i. Sprinkle placement
 - j. Quality control
5. Students will be given 5 minutes to determine where each station will be placed, and then they will mark it on the paper
6. After each of the stations is created, the timer will begin and the teams will work to decorate their 25 cookies
7. Suggested cookie design
 - a. Pink frosting base
 - b. 3 horizontal purple lines

- c. 3 vertical blue lines
 - d. 1 green spiral
 - e. Sprinkles on top (extract all brown sprinkles—for added complication)
8. Each team will be timed separately
 9. After each team has finished, the judging will begin
 10. Teams will be judged on uniformity and efficiency
 11. One point will be taken away for: each brown sprinkle found on the cookies, messed up lines, etc.

Conclusion

Wrap up the activity by asking the students if the process was easy or hard. Ask them to share their thoughts about the process. Reiterate the process involved with creating the final product.



MESA DAY CONTEST RULES 2015-2016

Speak Out

LEVEL:	9 th & 10 th grades
TYPE OF CONTEST:	Team
COMPOSITION OF TEAM:	A team = 3 students per team (teams are school-site based and must be composed of three members to participate in competition)
NUMBER OF TEAMS:	3 teams per Center
SPONSORS:	Dr. Maria Garcia-Sheets, University of the Pacific, MSP Center

OVERVIEW: Students will work as a team to choose a topic from the official presentation topic options. Team members will prepare and deliver a short oral presentation that clearly expresses their collective ideas. The competition is designed to encourage teamwork. The visual materials will reinforce the team's points. All team members will participate in the organization, preparation, and delivery of presentation.

Participation logistics, limits and facilities may vary by host site. Advisors and students are responsible to confirm logistics with their Center Director.

MATERIALS: The Host Center will provide the following:

- Presentation Topics (to be received in advance)
- Overhead Projector
- Flip Chart Stand

The Team will provide the following:

- Visual Material (Aid)

Before MESA Preliminaries, the Host Center will inform the Centers about whether, or not, a Data Projector and compatible Laptop Computer will be provided at MESA Day. It is the responsibility of the Advisors and students to confirm whether this optional equipment will be available before MESA Day, and to check about what format the Power Point Presentation should be transported and transmitted.

RULES:

- 1) A team consists of 3 members; each member of the team will actively, and equally, participate in the oral presentation.
- 2) Teams will select one topic from the official Topic list provided in advance of competitions.
- 3) Team members will practice their presentation before MESA Day; so all members know their presentation thoroughly. Students may speak from note cards, but they will not read their presentations.
- 4) Teams must use at least one visual aid or materials, such as a prop, model, chart, graph, picture, overhead transparency, or simple Power Point to reinforce their ideas.
- 5) An Overhead Projector and Flip Chart Stand will be available, if teams choose to use either one to display their visual materials.
- 6) Teams who advance to MESA Day Finals may use the same topic they prepared for the Preliminaries.
- 7) Teams are expected to research their topics, and to incorporate the researched concepts into their oral presentations. Team members may choose from these samples of research methods, or select their own: interview and quote knowledgeable people; use data from written sources, including relevant websites; find relevant illustrations, data, and examples.
- 8) Each team will have one (1) minute to prepare, and four to five (4 to 5) minutes to present.
- 9) Teams will draw numbers to determine their speaking order. Once the speaking order is established, no late arrivals may join the competition.
- 10) Once a presentation begins, interruptions will not be permitted.

JUDGING:

- 1) Judges will assemble all competing teams of students in the assigned room, read the rules, explain procedures, clarify judges' scoring criteria, and answer any related questions; teams not composed of three individuals will not be allowed to compete.
- 2) Judges will excuse all presenters from the room, and call in each competing team one-by-one.
- 3) Only Judges, appointed staff, and competing teams will be allowed in the room.
- 4) Judges will provide time signals for students at these intervals: One (1) Minute, Thirty (30) Seconds, and Five (5) Seconds before time is called.

- 5) Following each presentation, judges will evaluate each team according to the official Scoring Criteria before the next team is allowed in the room to begin its presentation.
- 6) Teams must give their presentations in the order drawn. No exceptions and no late arrivals allowed.
- 7) Judges will rate each team on a graduated scale for a possible total of 100 points. The Scoring Criteria consists of a rubric that includes areas pertaining to the overall team presentation: Content, Overall Presentation, Oral Performance, and Visual Performance.
- 8) A five-point (5) deduction will be taken if a presentation is less than four (4) minutes long, or more than five (5) minutes. Teams will be stopped if they exceed 5-1/2 minutes.
- 9) In the event of a tie, duplicate awards will be given.

AWARDS: Awards will be given for 1st, 2nd and 3rd place teams.

ATTACHMENTS: Topics
Scoring Criteria



MESA DAY CONTEST RULES 2015-2016

Speak Out TOPICS FOR ORAL PRESENTATION TEAM COMPETITION Grades 9-10

- Choose ONE of the three (3) topics listed below.
- Prepare your Team Oral Presentation to inform an audience, in this case, a panel of Judges.
- Help support your verbal presentation through an eye-catching visual aid or materials that are effective, straightforward, and educational. Your Visual Aid or Materials may be a Power Point presentation, overhead transparency slide(s), chart(s), model(s), prop, graph(s), picture(s), or other type of visual material.
- Prepare and practice your presentation before speaking, so that each team member is able to speak easily and directly to the audience. Note cards may be used for reference, but team members must not read their presentations.

Topics:

- 1. Discuss two current problems associated with the low number of Science, Technology, Engineering, and Math (STEM) college graduates experienced in the United States today, give two reasons why this is an important issue to address.**
- 2. Explain what Genetically Modified means when applied to food products, identify a food product that has been altered, then discuss one concern and one improvement made by that modification.**
- 3. Address Artificial Intelligence, explain the future potential for AI, and offer two examples of how AI would apply to robotics.**



Speak Out 9th – 10th Grade

Oral Presentation Scoring Criteria

Student name: _____

Grade: _____

School: _____

MESA Center: _____

Rate the speaker on each point:

E-excellent = 5

G-good = 4

A-average = 3

F-fair = 2

P-poor = 1

1. Introduction gained attention and interest	E	G	A	F	P
2. Main points clearly organized and easy to follow	E	G	A	F	P
3. Main points supported with sufficient evidence	E	G	A	F	P
4. Evidence from qualified sources	E	G	A	F	P
5. Reasoning clear and sound	E	G	A	F	P
6. Need issue dealt with convincingly	E	G	A	F	P
7. Speaker’s plan clearly explained	E	G	A	F	P
8. Practicality of plan demonstrated	E	G	A	F	P
9. Connectives used efficiently	E	G	A	F	P
10. Language is clear and concise	E	G	A	F	P
11. Conclusion reinforced the central idea	E	G	A	F	P
12. Sufficient eye contact	E	G	A	F	P
13. Voice used to add impact	E	G	A	F	P
14. Physical action effective	E	G	A	F	P
15. Speech well adapted to the audience	E	G	A	F	P
16. Visuals used to support and enhance ideas discussed	E	G	A	F	P

Comments:

Presentation Length: _____ mins & _____ sec

Time Deduction: YES/NO

Total Score: _____ /80

Judge: _____



MESA DAY CONTEST RULES 2015-2016

Speak Out

LEVEL:	11 th & 12 th grades
TYPE OF CONTEST:	Team
COMPOSITION OF TEAM:	A team = 3 students per team (teams are school-site based and must be composed of three members to participate in competition)
NUMBER OF TEAMS:	3 teams per Center
SPONSORS:	Dr. Maria Garcia-Sheets, University of the Pacific, MSP Center

OVERVIEW: Students will work as a team to choose a topic from the official presentation topic options. Team members will prepare and deliver a short oral presentation that clearly expresses their collective ideas. The competition is designed to encourage teamwork. The visual materials will reinforce the team's points. All team members will participate in the organization, preparation, and delivery of presentation.

Participation logistics, limits and facilities may vary by host site. Advisors and students are responsible to confirm logistics with their Center Director.

MATERIALS: The Host Center will provide the following:

- Presentation Topics (to be received in advance)
- Overhead Projector
- Flip Chart Stand

The Team will provide the following:

- Visual Material (Aid)

Before MESA Preliminaries, the Host Center will inform the Centers about whether, or not, a Data Projector and compatible Laptop Computer will be provided at MESA Day. It is the responsibility of the Advisors and students to confirm whether this optional equipment will be available before MESA Day, and to check about what format the Power Point Presentation should be transported and transmitted.

RULES:

- 1) A team consists of 3 members; each member of the team will actively, and equally, participate in the oral presentation.
- 2) Teams will select one topic from the official Topic list provided in advance of competitions.
- 3) Team members will practice their presentation before MESA Day; so all members know their presentation thoroughly. Students may speak from note cards, but they will not read their presentations.
- 4) Teams must use at least one visual aid or materials, such as a prop, model, chart, graph, picture, overhead transparency, or simple Power Point to reinforce their ideas.
- 5) An Overhead Projector and Flip Chart Stand will be available, if teams choose to use either one to display their visual materials.
- 6) Teams who advance to MESA Day Finals may use the same topic they prepared for the Preliminaries.
- 7) Teams are expected to research their topics, and to incorporate the researched concepts into their oral presentations. Team members may choose from these samples of research methods, or select their own: interview and quote knowledgeable people; use data from written sources, including relevant websites; find relevant illustrations, data, and examples.
- 8) Each team will have one (1) minute to prepare, and four to five (4 to 5) minutes to present.
- 9) Teams will draw numbers to determine their speaking order. Once the speaking order is established, no late arrivals may join the competition.
- 10) Once a presentation begins, interruptions will not be permitted.

JUDGING:

- 1) Judges will assemble all competing teams of students in the assigned room, read the rules, explain procedures, clarify judges' scoring criteria, and answer any related questions; teams not composed of three individuals will not be allowed to compete.
- 2) Judges will excuse all presenters from the room, and call in each competing team one-by-one.
- 3) Only Judges, appointed staff, and competing teams will be allowed in the room.
- 4) Judges will provide time signals for students at these intervals: One (1) Minute, Thirty (30) Seconds, and Five (5) Seconds before time is called.

- 5) Following each presentation, judges will evaluate each team according to the official Scoring Criteria before the next team is allowed in the room to begin its presentation.
- 6) Teams must give their presentations in the order drawn. No exceptions and no late arrivals allowed.
- 7) Judges will rate each team on a graduated scale for a possible total of 100 points. The Scoring Criteria consists of a rubric that includes areas pertaining to the overall team presentation: Content, Overall Presentation, Oral Performance, and Visual Performance.
- 8) A five-point (5) deduction will be taken if a presentation is less than four (4) minutes long, or more than five (5) minutes. Teams will be stopped if they exceed 5-1/2 minutes.
- 9) In the event of a tie, duplicate awards will be given.

AWARDS: Awards will be given for 1st, 2nd and 3rd place teams.

ATTACHMENTS: Topics
Scoring Criteria



MESA DAY CONTEST RULES 2015-2016

Speak Out TOPICS FOR ORAL PRESENTATION TEAM COMPETITION Grades 11-12

- Choose ONE of the three (3) topics listed below.
- Prepare your Team Oral Presentation to inform an audience, in this case, a panel of Judges.
- Help support your verbal presentation through an eye-catching visual aid or materials that are effective, straightforward, and educational. Your Visual Aid or Materials may be a Power Point presentation, overhead transparency slide(s), chart(s), model(s), prop, graph(s), picture(s), or other type of visual material.
- Prepare and practice your presentation before speaking, so that each team member is able to speak easily and directly to the audience. Note cards may be used for reference, but team members must not read their presentations.

Topics:

1. **Discuss why low numbers of Science, Technology, Engineering, and Math (STEM) college graduates in the United States is a concern for the future.**
2. **Explain why genetically modified wheat is controversial.**
3. **Discuss the implications of Artificial Intelligence and explain how it is being used today.**



Speak Out 11th – 12th Grade

Oral Presentation Scoring Criteria

Student name: _____

Grade: _____

School: _____

MESA Center: _____

Rate the speaker on each point:

E-excellent = 5 G-good = 4 A-average = 3 F-fair = 2 P-poor = 1

1. Introduction gained attention and interest	E	G	A	F	P
2. Main points clearly organized and easy to follow	E	G	A	F	P
3. Main points supported with sufficient evidence	E	G	A	F	P
4. Evidence from qualified sources	E	G	A	F	P
5. Reasoning clear and sound	E	G	A	F	P
6. Need issue dealt with convincingly	E	G	A	F	P
7. Speaker’s plan clearly explained	E	G	A	F	P
8. Practicality of plan demonstrated	E	G	A	F	P
9. Connectives used efficiently	E	G	A	F	P
10. Language is clear and concise	E	G	A	F	P
11. Conclusion reinforced the central idea	E	G	A	F	P
12. Sufficient eye contact	E	G	A	F	P
13. Voice used to add impact	E	G	A	F	P
14. Physical action effective	E	G	A	F	P
15. Speech well adapted to the audience	E	G	A	F	P
16. Visuals used to support and enhance ideas discussed	E	G	A	F	P

Comments:

Presentation Length: _____ **mins** & _____ **sec** **Time Deduction: YES/NO**

Total Score: _____ /80 **Judge:** _____



MESA DAY CONTEST RULES 2015-2016

Speak Up

LEVEL:	6th grade
TYPE OF CONTEST:	Individual Oral Presentation
NUMBER OF STUDENTS:	3 students per Center
SPONSORS:	Dr. Maria Garcia-Sheets, University of the Pacific MSP Center

OVERVIEW: Students will choose, prepare, and deliver a short, individual, oral presentation from the official topic options. Presentations must be the original work of the student, include a visual aid or materials to help support key points, and show evidence of research.

Participation logistics, limits and facilities may vary by host site. Advisors and students are responsible to confirm logistics with their Center Director.

MATERIALS: The Host Center will provide the following:

- Presentation Topics (to be received in advance)
- Overhead Projector
- Flip Chart Stand

The student presenter will provide the following:

- Visual Material (Aid)

Before MESA Preliminaries, the Host Center will inform the Centers about whether, or not, a Data Projector and compatible Laptop Computer will be provided at MESA Day. It is the responsibility of the Advisors and students to confirm whether this optional equipment will be available before MESA Day, and to check about what format the Power Point Presentation should be transported and transmitted.

RULES:

- 1) Students will select one topic from the official Topic list provided in advance of competitions.
- 2) Students will practice their presentations before MESA Day, so they know their presentations thoroughly. Students may speak from note cards, but they will not read their presentations.
- 3) Students will use a visual aid or materials, such as a prop, model, chart, graph, picture, overhead transparency, or simple Power Point to reinforce their ideas.
- 4) An Overhead Projector and Flip Chart Stand will be available, if students choose to use either one to display their visual materials.
- 5) Students who advance to MESA Day Finals may use the same topic as they prepared for the Preliminaries.
- 6) Students are expected to research their topics, and to incorporate the researched concepts into the oral presentations. Students may choose from these samples of research methods, or select their own: interview and quote knowledgeable people; use data from written sources, including relevant websites; find relevant illustrations, data, and examples.
- 7) Each student will have one (1) minute to prepare in the start, and two to three (2 to 3) minutes to present.
- 8) Students will draw numbers to determine their speaking order. Once the speaking order is established, no late arrivals may join the competition.
- 9) Once a presentation begins, no interruptions will be permitted.

JUDGING:

- 1) Judges will assemble all competing students in the assigned room, read the rules, explain procedures, clarify judging criteria, and answer any related questions.
- 2) Judges will excuse all speakers from the room, and call in each competitor one-by-one.
- 3) Only Judges, appointed staff, and competitors will be allowed in the room.
- 4) Judges will provide time signals for students at these intervals: One (1) Minute, Thirty (30) Seconds, and Five (5) Seconds before time is called.

- 5) Following each presentation, judges will evaluate each speaker according to the Evaluation Criteria, before the next speaker is allowed in the room to begin his or her presentation.
- 6) Student must give their presentations in the order drawn. No exceptions and no late arrivals will be allowed.
- 7) Judges will rate each student on a graduated scale for a possible total of 100 points. The Scoring Criteria consists of a rubric that includes areas pertaining to the student's overall presentation: Content, Overall Presentation, Oral Performance, and Visual Performance.
- 8) A five-point (5) deduction will be taken if a presentation is less than two (2) minutes long, or more than three (3) minutes. Speakers will be stopped if they exceed 3-1/2 minutes.
- 9) In the event of a tie, duplicate awards will be given.

AWARDS: Awards will be given for 1st, 2nd and 3rd place.

ATTACHMENTS: Topics
Scoring Criteria



MESA DAY CONTEST RULES 2015-2016

Speak Up TOPICS FOR ORAL PRESENTATION STUDENT COMPETITION Grade 6

- Choose ONE of the three (3) topics listed below.
- Prepare your Oral Presentation to present to an audience, in this case a panel of Judges.
- Depending upon the topic and your purpose, you may choose to *describe, inform, convince, compare, contrast*, or use a combination of these approaches.
- Help support your verbal presentation by using an eye-catching Visual Aid or Materials that are effective, straightforward, and educational. Your Visual Aid may be a Power Point presentation, overhead transparency slide(s), chart(s), model(s), prop, graph(s), picture(s), or other type of visual material.
- Prepare and practice your presentation before speaking, so that you are able to speak easily and directly to the audience. Note cards may be used for reference, but your presentation must not be read.

Topics:

- 1. Discuss Genetically Modified Food and explain one benefit and one drawback.**
- 2. Discuss two reasons why Science, Technology, Engineering, and Math (STEM) education is important to the United States.**
- 3. Explain why it is important for students to learn how to write computer code and give one example where “code” can be used.**



Speak Up 6th Grade

Oral Presentation Scoring Criteria

Student name: _____

Grade: _____

School: _____

MESA Center: _____

Rate the speaker on each point:

E-excellent = 5 *G-good = 4* *A-average = 3* *F-fair = 2* *P-poor = 1*

1. Introduction gained attention and interest	E	G	A	F	P
2. Main points clearly organized and easy to follow	E	G	A	F	P
3. Main points supported with sufficient evidence	E	G	A	F	P
4. Evidence from qualified sources	E	G	A	F	P
5. Reasoning clear and sound	E	G	A	F	P
6. Need issue dealt with convincingly	E	G	A	F	P
7. Speaker's plan clearly explained	E	G	A	F	P
8. Practicality of plan demonstrated	E	G	A	F	P
9. Connectives used efficiently	E	G	A	F	P
10. Language is clear and concise	E	G	A	F	P
11. Conclusion reinforced the central idea	E	G	A	F	P
12. Sufficient eye contact	E	G	A	F	P
13. Voice used to add impact	E	G	A	F	P
14. Physical action effective	E	G	A	F	P
15. Speech well adapted to the audience	E	G	A	F	P
16. Visuals used to support and enhance ideas discussed	E	G	A	F	P

Comments:

Presentation Length: _____ **mins** & _____ **sec**

Total Score: _____ /80

Judge: _____



MESA DAY CONTEST RULES 2015-2016

Speak Up

LEVEL:	7 th & 8 th grade
TYPE OF CONTEST:	Individual Oral Presentation
NUMBER OF STUDENTS:	3 students per Center
SPONSORS:	Dr. Maria Garcia-Sheets, University of the Pacific MSP Center

OVERVIEW: Students will choose, prepare, and deliver a short, individual, oral presentation from the official topic options. Presentations must be the original work of the student, include a visual aid or materials to help support key points, and show evidence of research.

Participation logistics, limits and facilities may vary by host site. Advisors and students are responsible to confirm logistics with their Center Director.

MATERIALS: The Host Center will provide the following:

- Presentation Topics (to be received in advance)
- Overhead Projector
- Flip Chart Stand

The student presenter will provide the following:

- Visual Material (Aid)

Before MESA Preliminaries, the Host Center will inform the Centers about whether, or not, a Data Projector and compatible Laptop Computer will be provided at MESA Day. It is the responsibility of the Advisors and students to confirm whether this optional equipment will be available before MESA Day, and to check about what format the Power Point Presentation should be transported and transmitted.

RULES:

- 1) Students will select one topic from the official Topic list provided in advance of competitions.
- 2) Students will practice their presentations before MESA Day, so they know their presentations thoroughly. Students may speak from note cards, but they will not read their presentations.
- 3) Students will use a visual aid or materials, such as a prop, model, chart, graph, picture, overhead transparency, or simple Power Point to reinforce their ideas.
- 4) An Overhead Projector and Flip Chart Stand will be available, if students choose to use either one to display their visual materials.
- 5) Students who advance to MESA Day Finals may use the same topic as they prepared for the Preliminaries.
- 6) Students are expected to research their topics, and to incorporate the researched concepts into the oral presentations. Students may choose from these samples of research methods, or select their own: interview and quote knowledgeable people; use data from written sources, including relevant websites; find relevant illustrations, data, and examples.
- 7) Each student will have one (1) minute to prepare in the start, and two to three (2 to 3) minutes to present.
- 8) Students will draw numbers to determine their speaking order. Once the speaking order is established, no late arrivals may join the competition.
- 9) Once a presentation begins, no interruptions will be permitted.

JUDGING:

- 1) Judges will assemble all competing students in the assigned room, read the rules, explain procedures, clarify judging criteria, and answer any related questions.
- 2) Judges will excuse all speakers from the room, and call in each competitor one-by-one.
- 3) Only Judges, appointed staff, and competitors will be allowed in the room.
- 4) Judges will provide time signals for students at these intervals: One (1) Minute, Thirty (30) Seconds, and Five (5) Seconds before time is called.
- 5) Following each presentation, judges will evaluate each speaker according to the Evaluation Criteria, before the next speaker is allowed in the room to begin his or her presentation.

- 6) Student must give their presentations in the order drawn. No exceptions and no late arrivals will be allowed.
- 7) Judges will rate each student on a graduated scale for a possible total of 100 points. The Scoring Criteria consists of a rubric that includes areas pertaining to the student's overall presentation: Content, Overall Presentation, Oral Performance, and Visual Performance.
- 8) A five-point (5) deduction will be taken if a presentation is less than two (2) minutes long, or more than three (3) minutes. Speakers will be stopped if they exceed 3-1/2 minutes.
- 9) In the event of a tie, duplicate awards will be given.

AWARDS: Awards will be given for 1st, 2nd and 3rd place.

ATTACHMENTS: Topics
Scoring Criteria



MESA DAY CONTEST RULES 2015-2016

Speak Up TOPICS FOR ORAL PRESENTATION STUDENT COMPETITION Grades 7-8

- Choose ONE of the three (3) topics listed below.
- Prepare your Oral Presentation to present to an audience, in this case a panel of Judges.
- Depending upon the topic and your purpose, you may choose to *describe, inform, convince, compare, contrast*, or use a combination of these approaches.
- Help support your verbal presentation by using an eye-catching Visual Aid or Materials that are effective, straightforward, and educational. Your Visual Aid may be a Power Point presentation, overhead transparency slide(s), chart(s), model(s), prop, graph(s), picture(s), or other type of visual material.
- Prepare and practice your presentation before speaking, so that you are able to speak easily and directly to the audience. Note cards may be used for reference, but your presentation must not be read.

Topics:

- 1. Discuss Genetically Modified Food and explain one benefit and one drawback.**
- 2. Discuss two reasons why Science, Technology, Engineering, and Math (STEM) education is important to the United States.**
- 3. Explain why it is important for students to learn how to write computer code and give one example where “code” can be used.**



Speak Up 7th – 8th Grade

Oral Presentation Scoring Criteria

Student name: _____

Grade: _____

School: _____

MESA Center: _____

Rate the speaker on each point:

E-excellent = 5 G-good = 4 A-average = 3 F-fair = 2 P-poor = 1

1. Introduction gained attention and interest	E	G	A	F	P
2. Main points clearly organized and easy to follow	E	G	A	F	P
3. Main points supported with sufficient evidence	E	G	A	F	P
4. Evidence from qualified sources	E	G	A	F	P
5. Reasoning clear and sound	E	G	A	F	P
6. Need issue dealt with convincingly	E	G	A	F	P
7. Speaker's plan clearly explained	E	G	A	F	P
8. Practicality of plan demonstrated	E	G	A	F	P
9. Connectives used efficiently	E	G	A	F	P
10. Language is clear and concise	E	G	A	F	P
11. Conclusion reinforced the central idea	E	G	A	F	P
12. Sufficient eye contact	E	G	A	F	P
13. Voice used to add impact	E	G	A	F	P
14. Physical action effective	E	G	A	F	P
15. Speech well adapted to the audience	E	G	A	F	P
16. Visuals used to support and enhance ideas discussed	E	G	A	F	P

Comments:

Presentation Length: _____ **mins** & _____ **sec**

Total Score: _____ /80 **Judge:** _____

Assembly Line

Objective: Students will explore industrial/manufacturing engineering utilizing an assembly line.

Team Members: 6-8

Time Frame: 60 minutes

Materials:

- Pieces of cloth (approximately 15 in by 15 in) (2 per group)
- Pairs of scissors (2 per group)
- Staplers, heavy duty preferred (2 per group)
- Felt markers (2 per group)
- Googly eyes, various sizes (try to divide evenly among teams. A bag of 400 is \$3 at Michaels)
- Bags dried beans (2 per group)
- Plastic spoon (1 per group)
- Styrofoam cup (1 per group)
- Printer paper

Procedure:

Pre-Activity: Assemble the materials for each team. Google “Beanie Fish” to have a visual for the students as you introduce the problem.

Intro: Part of engineering is being able to assemble a large quantity of a product in a short amount of time. Today, you will go through the process of designing a product and how to manufacture it quickly. (Show the picture of the beanie fish). You will have 35 minutes to design your version of the fish and the steps your assembly line will take to make it. You may only use the materials I give you. You will need to make a step by step list or a flowchart of your assembly line. Each person in your group will have a specific task as part of the assembly line. It needs to be approved before building may begin. Give each group 2 pieces of printer paper.

Activity: Let the students design their fish and decide on the steps that they will take to build it. Monitor the room. As students finish their step by step instructions, make sure they show them to you. Make sure that the list is logical (put the “stuffing” in before closing up the fish, etc). Once you have approved the list, give the students the material and ask them to make one fish. When they have completed their fish, have them review their instructions and see what adjustments need to be made. Have them refine their instructions and go back for approval again. They need to be prepared to justify why they made the changes again. Have them make the second fish and see if their process is better.

Closure: Have the students put their fish in a central location. Check to see if all the fish are usable or do they have flaws (not closed all the way, missing an eye, etc). Have the students

reflect on why these happen. Help them understand that speed does not translate to quality. Ask the students if the changes in their instructions improved their fish. Remind them of the importance of writing down your steps so you can make minor adjustments if needed.

Cantilever

Objective: Students will be able to design and build a cantilever.

Team Members: 2-4

Time Frame: 60 minutes

Material:

- Popsicle sticks (10 per group)
- Paper clips (15 per group)
- Straws (5 per group)
- Masking tape (2 meters per group)
- Pipe cleaners (10 per group)
- Newspaper (2 sheets per group)
- Measuring tape
- Stopwatch (www.onlinestopwatch.com is a great resource)

Procedure:

Pre-Activity: Make copies (front and back) of the Cantilevers handout. Assemble the kits for each team.

Intro: Pass out the Cantilevers handout. Have students take 5 minutes and brainstorm what a cantilever is. Have the students come up with the similarities of the pictures to construct the definition of a cantilever. When the group agrees on their definition, share the definition of a cantilever. [A cantilever is supposed because one end has more weight on it. The most stable cantilevers are short. Brackets can be used to support cantilevers. Sometimes, as the cantilever arm extends out, it gets narrower so that a bulk of the weight and support is near the base.] Ask the students to look at the pictures again and identify the cantilevers.

Activity: Tell the students that they are going to construct a cantilever. Hand out the Cantilever Competition Handout. Have them read it and ask for questions. Tell the students that they will have 15-35 minutes to build their cantilever. Start the timer. Monitor the room. Make sure that they are following the guidelines. Students will try to attach it to table. At the end of the time, tell students to stop working. Have them clean up their mess. Measure each cantilever and declare a winner.

Closure: Discuss the winning team's design. Ask the group what they would do differently if they could do it again. Talk about the importance of cantilevers in today's world and why they are useful.

Cantilevers

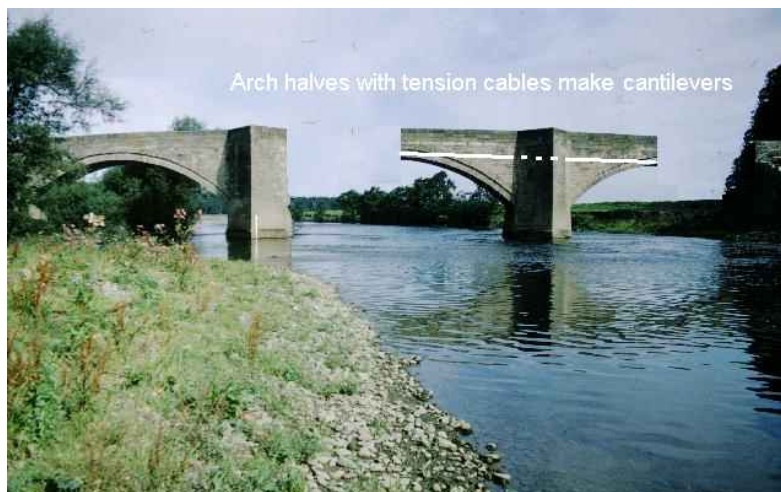
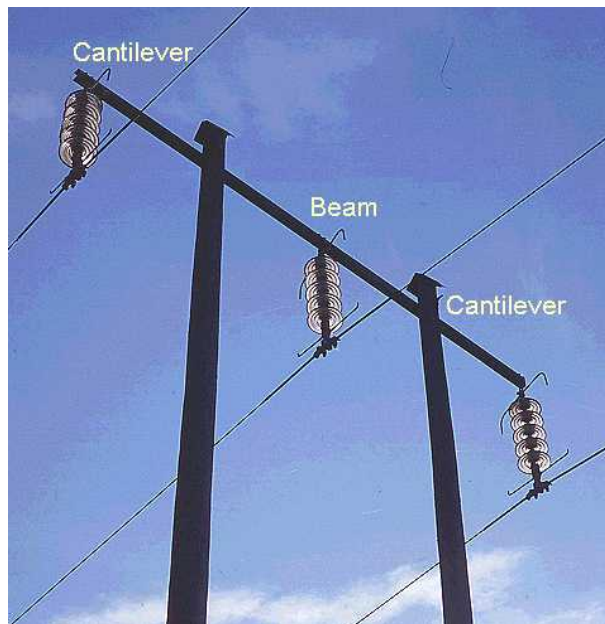



This tree is showing a natural cantilever. But, it is being supported by the 2 braces.

Cantilever Competition

Goal:

- Each team will build one cantilever using the given materials that will extend as far as possible off the table.
- The cantilever will stay on the table with its own weight and will not be fastened to the table with clay, glue, or tape.

Materials:

- 10 popsicle sticks
- 15 paperclips
- 5 straws
- 2 meters of masking tape
- 10 pipe cleaners
- 2 sheets of newspaper

Instructions:

1. Discuss cantilevers and cantilever designs with the group.
2. Read the 'Cantilever Competition' handout. Ask questions to make sure you understand the rules.
3. Get into teams of 2-3 students.
4. Get your supplies from the advisor.
5. Brainstorm with your team to quickly come up with a design that incorporates the given materials. Use what you have learned in the cantilever discussion.
6. Begin constructing your cantilever. Your advisor will tell you how much time you have.
7. When time is up, watch as the advisor measures how far out your cantilever projects off the table.

Rules:

1. You may not use clay or tape to keep your cantilever on the table. It must be supported by its own weight.
2. You may not share your materials with the other teams. You do not have to use all your materials, but you cannot give away materials you are not using.

Good Luck and Have Fun!

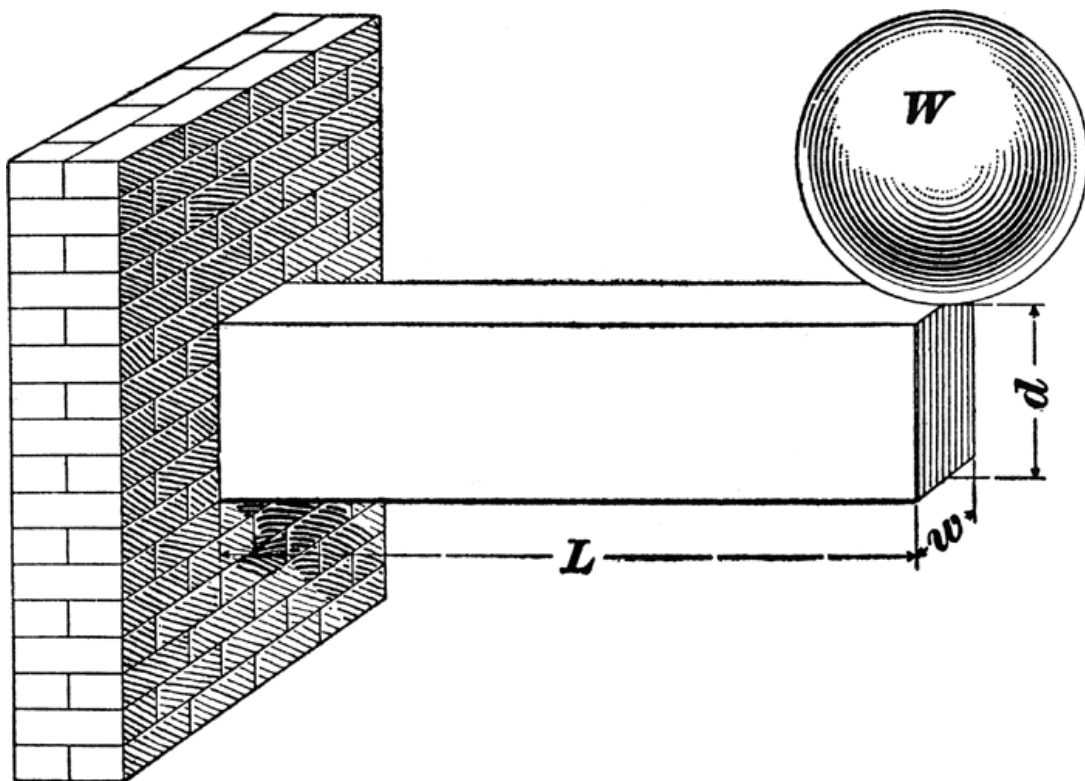

College Track

Objective: Students will become familiar with the Arizona Board of Regents requirements for entering a university. Students will be become familiar with the Admissions Review Process.

Team Members: None. Whole group activity

Time Frame: 60 minutes

Materials:

- Graduation Requirements for your district
- UA Admissions website: <https://admissions.arizona.edu/freshmen/entrance-requirements-and-guidelines>
- College Track Checklist
- Rolling Admissions Game board (1 per student)
- 6-sided die (1 per student)

Pre-lesson: Speak with a counselor or other knowledgeable person to see if they can help facilitate this discussion. It can make it easier to answer questions that students may or may not have. Make sure that you have enough of the materials for each MESA student.

Procedures:

Intro:

Begin the discussion about what students think they know about entering college. Do they know what classes are required? Do they know that they should take the SAT or ACT or both? Do they know what the graduation requirements are for them? Do students know when they should apply for college?

Activity:

Have students get into groups of 3-4. Have the students make 2 lists: High School Graduation requirements and Courses Required for UA Admission. Give the students 5 minutes to work together. At the end of the 5 minutes, bring the students back for a whole class discussions.

Have groups share their lists. Record the lists on the board. Look for any similarities and difference between the lists. When the group list is complete, project the UA Admissions website and compare the list on the website to the one that your students created. Have students discuss what are the similarities and differences. Be sure to point out the part of the websites about deficiencies. Students need to make sure that they fully understand what they need to do as students to gain university admission.

As part of the discussion, make sure that students know the AZ Board of Regents has the same requirements for all 3 universities (UA, ASU, NAU) so these requirements are standard across AZ. If they plan on going to a private college (GCU) or out of state, they need to check the school's website to see what the requirements are.

Students may or may not know if they are on pace for university admissions. This is why it is good to have a counselor present during this activity. The counselor can answer any questions and/or set up appointments to make sure that the students are on pace.

Hand out the Rolling Admissions game board and dice. Have students okay the game until everyone has completed the board. Ask if anyone reached the Comprehensive Review. Discuss what classes they are taking now and how they translate to the game.

Closure:

Talk to students about the importance of knowing what the admission requirements are for any university. Most universities and community colleges also require competency exams to make sure that students are appropriately placed in their classes. Make sure to emphasize that students need to advocate for their own future and classes. Their counselors are great resources to help them graduate high school with the appropriate credits needed for university admissions.



“Rolling” Admissions

<u>ABOR Course Competency</u>		2.0	Extra
English (4)	<input type="checkbox"/> <input type="checkbox"/> <input type="checkbox"/> <input type="checkbox"/>	<input type="checkbox"/>	
Math (4)	<input type="checkbox"/> <input type="checkbox"/> <input type="checkbox"/> <input type="checkbox"/>	<input type="checkbox"/>	
Science (3)	<input type="checkbox"/> <input type="checkbox"/> <input type="checkbox"/> <input type="checkbox"/>	<input type="checkbox"/>	
Soc Studies (2 + 1 _{HS})	<input type="checkbox"/> <input type="checkbox"/> <input type="checkbox"/> <input type="checkbox"/>	<input type="checkbox"/>	
Foreign Language (2)	<input type="checkbox"/> <input type="checkbox"/> <input type="checkbox"/> <input type="checkbox"/>	<input type="checkbox"/>	
Fine Arts/CTE (1)	<input type="checkbox"/> <input type="checkbox"/> <input type="checkbox"/> <input type="checkbox"/>	<input type="checkbox"/>	
	Top 25%	<input type="checkbox"/>	

- HS Grad** – Did you meet your graduation requirements? Assume you have all of your electives.
- ABOR Course Competency** – Have you taken all 16 course competency requirements?
Engl – 4, Math – 4, Science – 3, Social Studies – 2, Foreign Language – 2, Fine Arts – 1
- Assured Admission** – Did you meet course competency requirements, the minimum 2.0 GPA in each subject area, and are in the Top 25% of your class? If so, congratulations you are assured admission to the UA!
- Comprehensive Review** – If you did not get assured admission don’t worry, you can still be admitted to the university. In fact most of this year’s freshman class were admitted through comprehensive review. Let your admissions application prove you are college ready.

Rules:

Units

1. Roll a six-sided die
2. Result = # of units available
3. Choose a course competency category and use as many of the available units you would like.
Place any left over units into the extra box.

(example - If you roll a 5, you could put 4 units into Math and the remaining unit would go into extra.)

4. Repeat steps 1-5 until you have rolled for each course competency category.
5. Use the Extra to complete your course competency for university admissions and high school graduation
(example – your extra Math unit could be used to complete your Science units if you rolled a 2 for Science)

Grades

6. Roll the die once for each course competency category
7. If you roll at 2, 3, 4 or 5 put a check in the 2.0 box for that category.
8. If you roll a 6 check the 2.0 box for all categories and check the TOP 25% box. Congrats Brainiac! Skip to step 10.
9. Repeat steps 6 and 7 until you have rolled for each competency category or have rolled a six.

Graduation & Admissions

10. Complete the checklist

Design a Glider

Objective: Students will be able to design and build a glider.

Team Members: 4

Time Frame: 60-75 minutes

Materials:

- Stopwatch (<http://www.online-stopwatch.com/> is a great resource)
- Scale – measure in grams
- On-Site Data Collection Sheet
- Printer paper
- Card stock
- Masking Tape
- Elmer's glue
- Popsicle Sticks
- Pipe Cleaners
- Stapler
- Paper clips
- Scissors
- Other materials of your choice (cardboard, Styrofoam, balsa wood, etc)

Procedures:

Prep:

Divide the materials so that each group has:

- 2 pieces of paper
- 2 piece of cardstock
- Roll of tape
- Bottle of glue
- 12 popsicle sticks
- 6 pipe cleaners
- Stapler
- 10 paper clips
- 2 pairs of scissors

Any other material needs to be divided evenly amongst the groups.

You will need a space to throw the gliders. Pre-determine where that space will be. It will need to have room for the gliders to fly and land without interference.

Intro:

Tell the students that they are practicing their On-Site skills. Sometimes, you need to engineer something on the spot. Talk to the students that the important skills are being able to work under pressure, stay focused on a goal, and work well with your team.

Activity:

Divide students into groups of 4. Tell students that they cannot start until you tell them to. They will have 30 minutes to design and build their solution to the problem. Hand out the supplies to each group. Then, hand out the Glider specs. Tell the students to begin and start the time. As the students work, walk around and observe what they are doing. Do not answer any questions about how to build the glider. The students need to work as a group to solve the problems. Your role is as a judge. At the end of the 30 minutes, call time. Have the students clean up any mess that may be present. Have one student bring their glider to be weighed. Record the weights of the gliders on the Data Collection Sheet.

Have the group go to the launch point that you pre-determined. One at a time, have the students throw their gliders and measure how long it takes to land. Record the time on the Data Collection sheet.

Closure:

Talk about the strategies that students used during the build. Did those strategies help them in the build? Did all of the gliders work? If they could do it again, what would they do? Talk to the students about the importance of using the Engineering Design Process and drawing on their prior knowledge. They can use those skills in a setting like this to help them come up with the best solution.

ON-SITE ENGINEERING DESIGN
High School Level
Glider

OBJECTIVE:

Your engineering team has been hired to design and build a glider that will stay aloft for the greatest length of time. The team shall compete with other teams in a head-to-head competition.

MATERIALS:

- 2 - Pieces printer paper
- 2 - Pieces cardstock
- 1 - Roll of masking tape
- 1 - Bottle of white glue
- 6 - Pipe cleaners
- 10 - Paper clips
- 12 - Popsicle sticks

Other materials available for use but not included in the design:

Scissors Stapler Pencil Paper

RESTRICTIONS and INSTRUCTIONS:

1. All gliders must be powered by gravity; no other energy source will be allowed.
2. Glider must stay together in flight; gliders that fall apart will be disqualified. 3. No assistance and no physical contact can be made with your glider once launched.
4. A team representative will stand above the starting line. When signaled, the representative will drop the team's glider. The representative may not release the glider from any point beyond the starting line.
5. Time will begin when the glider is released from the representative's hand and end when the glider first hits the ground.

SCORING:

- Time will be measured by judge(s) using standard digital stop watches.
- Each glider will be weighed for tie-breaking purposes.

Time ties will be broken by using the lightest glider!

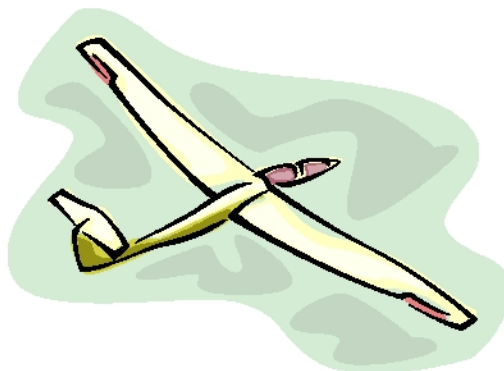

ON-SITE ENGINEERING DESIGN
High School Level
Glider

Data Collection Sheet

Group Members	Weight (g)	Time (s)

Electrical Engineering Basics

Objectives: Students will be able to build a battery. Students will be able to describe how current and voltage relate. Students will learn about parallel and series circuits.

Team Members: 2-4

Time Frame: 45 minutes

Materials:

- Potatoes (1 per group)
- Lemons (1 per group)
- Galvanized (molten, not electrogalvanized) nails (4 per group)
- 3 inch copper wire sections (2 per group)
- 2 wires with alligator clips on the ends
- Sandpaper
- Multimeter

Procedure:

Intro: Tell the students that today they are going to work with electricity. Remind students that safety needs to be the first thing they are thinking about. Electricity can be dangerous and you cannot play with it. Tell them that they will be building simple batteries and testing to see how to generate the most electricity.

Activity: Give the students the potatoes, nails, copper wire and wire. Have the students take one piece of wire and wrap it around a nail so that about 2.5 inches are sticking off from the nail and about .5 inch is wrapped around it. Repeat with the second piece of wire and a different nail. Take one nail with wire and one nail without wire and put them on opposite sides of the potato. The copper wire should not touch the other nail. Use the multimeter and read the voltage and current on the potatoes. Have the students record the results. Repeat the procedure with the lemon.

Have a discussion about which produced more energy (it should be the potato). Ask students why they think that happens. Ask them if there is a way to increase the energy coming from the lemons and potatoes. This will lead to the discussion about parallel and series circuits.

Parallel circuit: A parallel circuit is a circuit where the electricity runs through 2 or more paths at the same time.

Series circuit: A series circuit is a circuit where the electricity runs in a single path through multiple pieces.

Connect the batteries in parallel. Measure the voltage and current. Connect the batteries in series. Measure the voltage and current. Write the values on the board and clean up your space.

Closure: Have students discuss the results of parallel vs series batteries. What are the advantages to both types of circuit?

This is the basis for electrical engineers. How can we manipulate electricity so it will do what we want? If we understand how to speed it up/slow it down and increase/decrease the amount we have, we can operate anything from a car (12 V battery) to heavy manufacturing machines which can use 10,000-30,000 V.

Graphing Battleship

Objectives: Students will be able to enhance their graphing abilities by playing “Battleship” on a coordinate axis.

Team Members: 2 per group

Time Frame: Variable. Can take from 10-30 minutes

Materials:

- Graph paper (<http://www.printfreegraphpaper.com/> is a great site to make your own)
- Large book or other divider
- Pen
- Highlighter

Procedure:

Intro: Graphing in math is an important skills. It is a great way to show trends, rates of change, or illustrate a point with a pictorial representation. One skill that we need to master is graphing on a coordinate axis. Today, you are going to play Battleship but using graphs to do it. Make sure everyone understands the rules of Battleship.

Rules of Battleship:

- You have 5 ships. Sizes: 2, 3, 3, 4, 5 dots
- The ships must go onto the board. Parts cannot hang off
- Ships may go vertically or horizontally. Diagonals are also an option if you choose
- Take turns “shooting” at each other’s ships. Must shoot in the form of a point (x,y).
- When a ship is sunk (i.e. all points are discovered), you say “You sunk my ship.”
- First one to sink all 5 ships wins

Hand out the graph paper. Give each student two pieces

Activity:

Have the students draw a square in the center of their paper that is 10 x 10 squares. In the center of the squares, draw an X and Y axis. Each quadrant should be 5x5 squares. Have the students label the graphs “Home” and “Aiming.” Place a divider between the opponents so they cannot see what is on the opponent’s graph.

Have the students place their battleship on their “Home” graph – one of 2 dots, two of 3 dots, one of 4 dots and one of 5 dots. Have the students use the highlighter to highlight the line to represent their ships.

Players then take turns trying to hit each other's ships. On the "Aiming" graph, have the students write an "X" for a hit and a dot for a miss. The first student to sink all 5 ships wins.

Closure:

Explain to students that this activity is a simplified version of targeting software used by the military or GPS devices that are on their phones. Explain that graphing allows us to do a lot more than just draw a line. You can make a graph out of anything. Graphing is a skill that is essential for today's world.

Index Car Tower

Objectives: Students will be able to design and build a tower made of index cards.

Team Members: 2-4

Time Frame: 60 minutes

Materials:

- Stopwatch (www.onlinestopwatch.com is a great resource)
- Measuring Tape – 1 per group
- Clipboard – 1 per group
- Textbooks – try to make the same size and weight
- Scale
- Index cards – 100 per group

Pre-Activity: Gather the necessary materials and separate them out per group.

Procedures:

Intro: Tell the students that today they are going to build a tower that uses the least amount of materials to hold the most weight. Hand out the “Index Card Tower Design” specifications. Have the students read through it. Make sure they understand the constraints and goal. Ask for any questions.

Activity: Tell the students to begin and start the 30 minute timer. Your role at this point is as a judge. Have the students work together to create their solution. Only answer clarifying questions. Watch the groups and make note of any interesting ideas/conversations.

When the timer has ended, tell the students to stop. Have the students clean up any mess so there are no cards or materials around the tower. Begin the testing procedure. Place the clipboard on top of the tower and then start to stack the textbooks. Once the tower collapses, take off the book that caused the collapse and weigh the materials. Have the students count the cards and record their results on the specs in the appropriate place. Once you have tested all the towers, have the students write their results on the board to see how everyone did.

Closure: Ask the students why this is a useful activity. You want them to get to the point where they are apply physics but also extending it to buildings and why materials need to be strong but also used wisely. One of the jobs of an engineer is to come up with the most cost effective solution. Ask students what they could do to modify or improve their results.

Index Card Tower Design Competition

Goal:

Your team will build a tower that carries the greatest amount of weight using the least amount of index cards.

You will work in teams of 2-4 students and must build a tower that is at least 11 inches tall. Your team will get 100 index cards. You do not have to use all the cards, in fact, you want to construct a strong tower using the least amount of cards.

The cards can be cut, folded, and twisted to achieve your tower goals. You may not use glue, staples, fasteners, tape, or other binding materials in your tower.

Team Materials:

100 3" x 5" Index Cards

Instructions:

1. Read Index Card Tower Design Competition Handout.
2. Ask questions to make sure you understand the rules.
3. Get supplies.
4. Your team has 30 minutes to construct the tower.
5. When time is up, clean up your area and wait for your tower to be tested.

Competition:

A piece of ¼" plywood (clipboard) will be put on top of your tower. Books will be stacked on the plywood until the tower collapses. When the tower collapses, your team and advisor will find the total weight of the plywood, books, and index cards. Using the simple formula below, your team will find the weight carried per card. The team with the most weight per card calculation has built the strongest tower.

$$\frac{\text{Total Weight of plywood, textbooks, and index cards}}{\text{Total Number of Index Cards}} = \frac{\text{Weight Carried}}{\text{Card}}$$

MESA Lesson Activity

Suggested Sequence of Activities	<ul style="list-style-type: none"> • Math Puzzles: Hans and Gerrie, Birthday Cake (15 minutes) • Toothpick Dome (40-45 minutes) • MESA Calendar (15-20 minutes)
Duration	70-80 minutes
Age Level	Middle School
Essential Question	What makes a geodesic dome strong?
Learning Objectives	<p>Math Puzzles</p> <ul style="list-style-type: none"> • TSW solve higher order math logic puzzles using grade level problem solving strategies • TSW use reasoning to solve mathematical logic puzzles using given information <p>Toothpick Dome</p> <ul style="list-style-type: none"> • TSW identify the triangle as a very stable shape used in engineering and construction • TSW describe qualities that make a triangle very stable • TSW identify the weak point in a triangle (joint area) • TSW apply their understanding of triangular strength to the engineering of a geodesic dome • TSW discuss, re-explain, and demonstrate how a geodesic dome distributes the weight load over all the different triangles that compose it • TSW apply their overall understanding of geodesic domes to design and construct one using the given materials in the given time • TSW describe the construction process of their dome and evaluate its strengths and weaknesses by comparing it to other domes constructed by their peers
Other Objectives	<ul style="list-style-type: none"> • TSW develop a working plan with their group to develop a cooperative environment • TSW communicate with their group by contributing their vocal input
Key Terms	<ul style="list-style-type: none"> • Logical thinking • Geodesic dome • Polygon • Triangle • Compression • Tension • Weight distribution
Materials Needed	<p>Math Puzzles</p> <ul style="list-style-type: none"> • Handout with logic puzzles: Hans and Gerrie and Birthday Cake <p>Geodesic Dome</p> <ul style="list-style-type: none"> • Pictures of some geodesic domes: Epcot, Biosphere <p>Per group of 2-3 students</p> <ul style="list-style-type: none"> • 100 round toothpicks • 30-40 small marshmallows <p>Per student</p> <ul style="list-style-type: none"> • Engineer's Notebook Handout <p>MESA Calendar</p> <ul style="list-style-type: none"> • MESA Calendar Handouts or Overhead
Lead In	<p>Math Puzzles</p> <ol style="list-style-type: none"> 1. Pass puzzles out to students as they arrive for MESA meeting. Remind them to sign in on attendance sheet. 2. Inform students that they may work individually or in groups of 2. Instruct them not to give the answer if they solve it before time is up. 3. Monitor and guide students to the solution. 4. After 10-15 minutes, discuss each puzzle, its solution, and the logic reasoning

	<p>student used to solve it. Call on students at random or have them volunteer to explain their problem solving strategies.</p>
<p>Activity</p>	<p>Geodesic Dome</p> <ol style="list-style-type: none"> 1. Pass out the Engineer's Notebook handout. Tell them that they will be completing this handout for each MESA activity. Tell them you will guide them through the handout today. 2. Show the students images of some geodesic domes. 3. Ask them to point out similarities. Write these on the board. 4. Ask them to point out differences. Write these on the board. 5. Guide students to identify the types of shapes used in geodesic dome design, specifically, triangles. 6. Write the term 'Geodesic Dome' on the board. Instruct them to write it in the key term section of the Engineer's Notebook Handout. 7. Ask one student to find the definition in a dictionary and read it aloud. Write this definition on the board but instruct them not to write it on their handout. Simplify the definition into grade appropriate terminology using the images as teaching tools. Students will create a communal oral definition, write this on the board, and have them copy this into their handout. <div data-bbox="477 779 1432 926" style="border: 1px solid black; padding: 5px; margin: 10px 0;"> <p><i>Example of a Dictionary Definition: A domed or vaulted structure of lightweight straight elements that form interlocking polygons.</i> <i>Example of Student Definition: A structure made of connected polygons.</i></p> </div> <ol style="list-style-type: none"> 8. Write the term 'polygon' on the board and have them follow the same procedure as above. When they come to writing their own definition, one suggestion is to have them draw types of polygons next to the definition instead of using vocabulary. <div data-bbox="477 1108 1432 1230" style="border: 1px solid black; padding: 5px; margin: 10px 0;"> <p><i>Example of a Dictionary Definition: A closed plane figure bounded by 3 or more line segments.</i> <i>Student Definition: drawn polygon shapes</i></p> </div> <ol style="list-style-type: none"> 9. Write the term 'triangle' on the board and follow the same steps as for 'polygon'. They will draw the definition on the handout. 10. Show students a toothpick square. Ask them to identify what makes it a square. Discuss. 11. Ask students to point out where they think the weakest area/point of the square is. Most students will point to the joint area at the marshmallows. 12. Show the students a toothpick triangle. Ask them to identify what makes it a triangle. Discuss. 13. Ask students to point out where they think the weakest area/point of the triangle is. Most students will point to the joint area at the marshmallows. 14. Hold up both the toothpick square and the toothpick triangle. Point out obvious shape differences. 15. Ask, "Which of these two toothpick structures is more stable or stronger?" Solicit answers, write them on the board, and discuss. <div data-bbox="453 1663 1432 1864" style="border: 1px solid black; padding: 5px; margin: 10px 0;"> <p><i>A dome must support its own dead load as well as the live load of wind, rain, snow, or ice. The geodesic dome's strength is due to the fact that triangles are very stable shapes. It is difficult to distort a triangle; compression at one joint is balanced by tension along the opposite side. The geodesic dome's design distributes loads over all the different triangles that comprise it.</i></p> </div>

	<ol style="list-style-type: none"> 16. Have one student come up to apply pressure to both toothpick structures. The square toothpick structure should collapse easily. You may also choose to do this part of the demonstration yourself to ensure it does. 17. Ask students, "Why is the triangle toothpick structure more stable?" Solicit answers and discuss. 18. Put the following terms on the board: 'compression' and 'tension' 19. Use the demonstration to help the students define these terms or use the dictionary as a starting point and the students can come up with their own definition again. Have students write the definition on their handout. 20. Show students pictures of geodesic domes again and ask them to describe how they would build one using toothpicks and marshmallows. Point to the toothpick triangle as a start off point. Discuss and draw on the board or model for them by adding to the triangle. 21. Tell students that they will be engineering and constructing a geodesic dome using the concepts they just learned. 22. Pass out supplies to each group. 23. Tell students to write what materials they are using under the 'Materials Used' section of their Engineer's Notebook handout. 24. Students will begin activity. 25. Monitor student progress. Check to make sure the base of the geodesic dome is reasonable. Some may try to make a very large base and not complete their dome in the remaining time. 26. As groups finish, instruct them to begin the 'Procedure' section of the Engineer's Notebook handout. They will write down all the steps they took to build their geodesic dome. 27. Allow time for clean up.
<p>Closure</p>	<ol style="list-style-type: none"> 1. Put pressure on top of each groups dome with books to check the strength and stability. Use one groups dome as a class model. 2. Ask students to describe how the whole structural design makes it strong. Discuss. Mention how the dome design gives even weight distribution and briefly explain what weight distribution means by going back to the book support model. 3. Have student groups hold up and demonstrate their constructed domes. 4. Each group will describe what difficulties they had in constructing their domes. 5. Point to the Engineer's Notebook Handout. 6. Instruct students to complete the 'Procedure' section if they did not complete it. 7. Write the following question on the board: 'What makes a geodesic dome strong?' Instruct students to answer this question on the 'Conclusion' section of the Engineer's Notebook handout. 8. Point out the back of the handout. It is up to you for them to draw a picture of their completed dome before the next meeting. They can label it pointing out joints, tension, and compression. <p><i>*Note: Students may complete the 'Procedure' and 'Conclusion' section of the Engineer's notebook at home before the next MESA meeting if time is an issue.</i></p> <p>MESA Calendar</p> <ol style="list-style-type: none"> 1. Pass out a MESA calendar for the year or show them on an overhead. 2. Point out all the dates that involve students and give them a brief explanation of what will happen at each event. 3. When discussion Southern Regionals and MESA Day, emphasize that students will be engineering and constructing projects just like the geodesic dome in competition. 4. Ask for questions and discuss.
<p>Informal Assessment</p>	<ul style="list-style-type: none"> • Monitor students to check for understanding • Monitor students to check for participation

Formal Assessment	<ul style="list-style-type: none"> • Completed Geodesic Dome • Completed Engineer’s Notebook Handout (They may complete this before the next MESA meeting) 						
Trouble Shooting	<ul style="list-style-type: none"> • Keep an eye on the time. Don’t linger too long over a single component or you will run out of time. • Have additional supplies ready for groups that work quickly. They can add to the base of their dome. • Make sure all students participate in clean up. 						
SEI Strategies Used <table border="0" style="width: 100%;"> <tr> <td style="vertical-align: top;"> Preparation <input checked="" type="checkbox"/> Adaptation of Content <input type="checkbox"/> Links to Background <input type="checkbox"/> Links to Past Learning <input checked="" type="checkbox"/> Strategies incorporated </td> <td style="vertical-align: top;"> Scaffolding <input checked="" type="checkbox"/> Modeling <input checked="" type="checkbox"/> Guided practice <input type="checkbox"/> Independent practice <input checked="" type="checkbox"/> Comprehensible input </td> <td style="vertical-align: top;"> Grouping Options <input type="checkbox"/> Whole class <input checked="" type="checkbox"/> Small groups <input checked="" type="checkbox"/> Partners <input type="checkbox"/> Independent </td> </tr> <tr> <td style="vertical-align: top;"> Integration of Processes <input checked="" type="checkbox"/> Reading <input checked="" type="checkbox"/> Writing <input checked="" type="checkbox"/> Speaking <input checked="" type="checkbox"/> Listening </td> <td style="vertical-align: top;"> Application <input checked="" type="checkbox"/> Hands-on <input checked="" type="checkbox"/> Meaningful <input checked="" type="checkbox"/> Linked to objectives <input checked="" type="checkbox"/> Promotes engagement </td> <td style="vertical-align: top;"> Assessment <input type="checkbox"/> Individual <input checked="" type="checkbox"/> Group <input checked="" type="checkbox"/> Written <input checked="" type="checkbox"/> Oral </td> </tr> </table>		Preparation <input checked="" type="checkbox"/> Adaptation of Content <input type="checkbox"/> Links to Background <input type="checkbox"/> Links to Past Learning <input checked="" type="checkbox"/> Strategies incorporated	Scaffolding <input checked="" type="checkbox"/> Modeling <input checked="" type="checkbox"/> Guided practice <input type="checkbox"/> Independent practice <input checked="" type="checkbox"/> Comprehensible input	Grouping Options <input type="checkbox"/> Whole class <input checked="" type="checkbox"/> Small groups <input checked="" type="checkbox"/> Partners <input type="checkbox"/> Independent	Integration of Processes <input checked="" type="checkbox"/> Reading <input checked="" type="checkbox"/> Writing <input checked="" type="checkbox"/> Speaking <input checked="" type="checkbox"/> Listening	Application <input checked="" type="checkbox"/> Hands-on <input checked="" type="checkbox"/> Meaningful <input checked="" type="checkbox"/> Linked to objectives <input checked="" type="checkbox"/> Promotes engagement	Assessment <input type="checkbox"/> Individual <input checked="" type="checkbox"/> Group <input checked="" type="checkbox"/> Written <input checked="" type="checkbox"/> Oral
Preparation <input checked="" type="checkbox"/> Adaptation of Content <input type="checkbox"/> Links to Background <input type="checkbox"/> Links to Past Learning <input checked="" type="checkbox"/> Strategies incorporated	Scaffolding <input checked="" type="checkbox"/> Modeling <input checked="" type="checkbox"/> Guided practice <input type="checkbox"/> Independent practice <input checked="" type="checkbox"/> Comprehensible input	Grouping Options <input type="checkbox"/> Whole class <input checked="" type="checkbox"/> Small groups <input checked="" type="checkbox"/> Partners <input type="checkbox"/> Independent					
Integration of Processes <input checked="" type="checkbox"/> Reading <input checked="" type="checkbox"/> Writing <input checked="" type="checkbox"/> Speaking <input checked="" type="checkbox"/> Listening	Application <input checked="" type="checkbox"/> Hands-on <input checked="" type="checkbox"/> Meaningful <input checked="" type="checkbox"/> Linked to objectives <input checked="" type="checkbox"/> Promotes engagement	Assessment <input type="checkbox"/> Individual <input checked="" type="checkbox"/> Group <input checked="" type="checkbox"/> Written <input checked="" type="checkbox"/> Oral					
Arizona Math Standards Addressed	<ul style="list-style-type: none"> • S5C1: TSW use reasoning to solve mathematical problems in contextual situations to solve a simple logic problem from given information 						
Arizona Science Standards Addressed	<ul style="list-style-type: none"> • S1C1: TSW formulate predictions and questions based on observations. • S1C2: TSW design a controlled investigation and keep a record of their observations, notes, and sketches. • S1C4: TSW communicate the results of their investigation and create a list of instructions that others can follow. • S2C2: TSW understand how science is a process for generating knowledge and apply scientific processes to problem solving situations. 						



Lesson Activity

Duration	3 weeks
Sequence of Activities	<p>Week 1</p> <ul style="list-style-type: none"> • MESA Activity: Mousetrap Car (50-60 minutes) <p>Week 2</p> <ul style="list-style-type: none"> • MESA Activity: Mousetrap Car (50-60 minutes) <p>Week 3</p> <ul style="list-style-type: none"> • MESA Activity: Mousetrap Car (50-70 minutes)
Duration	60-80 minutes
Age Level	High School
Essential Question	How do Newton's 3 Laws of motion affect the motion of my mousetrap car? What kind of modifications can I make to a car that will address the forces of friction and gravity?
Learning Objectives	<p>Mousetrap Car</p> <ul style="list-style-type: none"> • TSW identify and recognize Newton's 3 Laws of Motion • TSW describe how Newton's 1st Law affects the motion of an object • TSW describe how we can calculate the force of an object by using the formula $F=ms$ • TSW describe how Newton's 3rd Law affects the motion of an object • TSW design and construct a mousetrap vehicle using given materials • TSW devise a mousetrap car design concept with their partner that is powered by the mousetrap and activated by tripping the original mousetrap trip mechanism • TSW modify their design to improve the overall structure • TSW submit a final mousetrap car that addresses the following challenges: travels the furthest distance up a 30 degree incline and travels 10 meters in the shortest time • TSW evaluate the strengths and weaknesses of their design and their mousetrap car • TSW compare their design concept and their mousetrap car design to those of their peers • TSW describe the process they took to complete the mousetrap car project • TSW explain how Newton's Laws are affecting the motion of their car • TSW calculate the force of their vehicle traveling up the 30 degree incline and calculate the force of their car traveling 10 meters in the shortest time

Other Objectives	<ul style="list-style-type: none"> • TSW develop a working plan with their group to develop a cooperative environment • TSW communicate with their group by contributing their vocal input • TSW listen as their peers discuss the design of their investigation • TSW write down the procedure they used to design their project
Key Terms	<ul style="list-style-type: none"> • Speed • Velocity • Acceleration • Force • Friction • Gravity
Materials Needed	<p><u>Week 1</u></p> <p>MESA Activity: Mousetrap Car</p> <p>For Group</p> <ul style="list-style-type: none"> • Toy cars (2) • balloon <p>Per Student</p> <ul style="list-style-type: none"> • Handout: Newton's 3 Laws of Motion • Handout: Types of Forces <p>Per Team (2-3 students)</p> <ul style="list-style-type: none"> • Handout: Mousetrap Car Competition • Drawing Paper • Colored Pencils <p><u>Week 2</u></p> <p>MESA Activity: Mousetrap Car</p> <p>For Group</p> <ul style="list-style-type: none"> • Box of assorted materials for teams to use as additional resources <p>Per Student</p> <ul style="list-style-type: none"> • Handout: Mousetrap Car Competition <p>Per team (2-3 students)</p> <ul style="list-style-type: none"> • Team Mousetrap Car Design from Week 3 • 1 Mousetrap • Materials brought from home that fulfill the team's design <p><u>Week 3</u></p> <p>MESA Activity: Mousetrap Car</p> <p>• Handout: MESA Diary</p> <p>For Group</p> <ul style="list-style-type: none"> • Ramp at 30 degree angle to test for power • Track measured out to specification to test for speed • Stopwatch

	<p>Per Student</p> <ul style="list-style-type: none"> • Handout: MESA Notebook • Handout: Mousetrap Car Competition • Handout: Newton's 3 Laws of Motion • Handout: MESA Mousetrap Car Speed Competition • Handout: MESA Mousetrap Car Power Competition <p>Per Team (2-3 students)</p> <ul style="list-style-type: none"> • Mousetrap Car • Team Mousetrap Car Design from Week 3
<p>Week 1</p>	<p>Mousetrap Car</p> <ol style="list-style-type: none"> 1. Pass out Handout: Newton's 3 Laws of Motion 2. Read handout and discuss each law. Use examples to demonstrate how the laws apply to motion. <div style="border: 1px solid black; padding: 10px; margin: 10px 0;"> <p><i>Examples:</i></p> <p><u>Newton's First Law:</u> Push a toy car across a table. Ask them why it stops. It stops because of friction and gravity, 2 forces acting on the car. If there were no forces acting on the car, it would remain in motion.</p> <p><u>Newton's 2nd Law:</u> $f=ma$ You can do a basic comparison. Obviously, the force of an object will increase if either the mass or the acceleration increases. You can use 2 toy cars to demonstrate this. Identical cars at identical masses, except one car is going faster than the other and will contribute to a higher force. You may want to tell them that force is measured in a unit called a Newton.</p> <p><u>Newton's 3rd Law:</u> Crawl on a table. Ask students, "Why am I not falling through the table?" The answer is that the table is pushing up on you. Newton's 3rd law states that bodies exhibit equal force on each other. Blow up a balloon. Let it go and watch it fly through the air. Ask students, why does the balloon fly? Where is the force being applied? The air being released from the balloon is pushing against the air on the outside.</p> </div> <ol style="list-style-type: none"> 3. Ask students to think about other examples of Newton's 3 Laws of Motion. Discuss. 4. Pass out the handout: Types of Forces 5. Discuss handout and ask students to come up with more examples of forces. Add these to the handout. 6. Tell students that they will be building a mousetrap car that will demonstrate Newton's 3 laws of motion. Their car will be acted on by outside forces such as friction and gravity. 7. Pass out handout: Mousetrap Car Competition. 8. Read handout completely as it addresses the rules and specifications for building and competing the cars. Have students retell you in their own words after each section. When discussing the competition aspect of the project, students may ask how far 10 meters is for the speed race. Show them by pointing out a 10 meter distance in the room. If students ask how much a 30 degree angle is, model it for them using objects in the room or the ramp.

	<ol style="list-style-type: none"> 9. Tell students that the project will take 3 MESA meetings. You may want to write this on the board. This first meeting will cover the rules and specifications. They will also be designing their vehicle and drawing it on drawing paper. The second meeting will be set aside for building the vehicle. The third meeting will be set aside for testing the vehicle and the actual competition. 10. Have students break up into teams of 2 or 3. 11. Show students a mousetrap and ask them to retell you what they can do with the mousetrap and what they cannot do. Demonstrate how a mousetrap works. Some students already know, but some have not. Discuss the mechanism and ask how the mechanism demonstrates Newton's Laws of Motion. (Newton's 3rd Law- The action of the spring exerts a force that is equal to how hard the clamp closes.) 12. Pass out drawing paper to the teams. Pass out colored pencils. Tell them they have 20-35 minutes to come up with a design. The mousetrap is going to be provided to them. They must bring other objects from home to add to the mousetrap. 13. Write the following questions on the board: What will the wheels be? What can I add to make it go faster? What can I add to make it go up the ramp better? Discuss modifications and how modifications improve a vehicle's performance. 14. Monitor and check student progress. Make sure their concept drawing is addressing competition rules and specifications. Make sure their materials are reasonable things they can easily get from home. 15. Have students add arrows to their drawing that label where friction and gravity will be acting on their vehicle. (Friction will be acting on their wheels and gravity will be pushing down on the vehicle.) 16. During the last 5 minutes of project time, tell teams to assign materials. Who is going to bring materials for the next meeting? (You may want to follow up this meeting with an email to all MESA students reminding them to bring their materials for the next meeting.) 17. Collect drawing from each team. Collect handouts from each student. 18. Clean up.
<p>Week 2</p>	<p>Mousetrap Car</p> <ol style="list-style-type: none"> 1. Have students get with their teams. 2. Pass out Handouts to students: Newton's 3 Laws of Motion, Types of Forces and Mousetrap Car Competition. Review with students and have them give you other examples of Newton's 3 Laws and Types of forces. Discuss rules for competition. 3. Pass out team drawings. 4. Have teams get out their supplies that they brought from home. 5. Tell teams that you also have a box of assorted supplies they may use, too. 6. Give them 5 minutes to gather their supplies and to go through your supplies. 7. After 5 minutes, ask teams if they need to modify their drawings based on their supplies. If they do, they may do so now. Pass out colored pencils to the teams that need to modify their design.

	<ol style="list-style-type: none"> 8. Tell teams they have 25-40 minutes to build their car. Advise them to work together in their teams and to ask for help from the advisor when they need it. 9. Monitor student progress and check to make sure their car construction follows their design concept closely. 10. If a team gets done constructing their car, they may test it to see if it works. 11. Allow the last 5 minutes for clean up. 12. Have students put their cars in a safe, designated area in your room.
Week 3	<p>Mousetrap Car</p> <ol style="list-style-type: none"> 1. Pass out Handout: Mousetrap Car Competition 2. Discuss competition rules again to clarify. 3. Show them area for Speed competition. Point out dimensions and clarify questions. Pass out handout: MESA Mousetrap Car Speed Competition to each student and explain how it needs to be filled out. See sample sheet. 4. Show them 30 degree ramp incline for Power Competition. Clarify any questions. Pass out Handout: MESA Mousetrap Car Incline Competition to each student and explain how it needs to be filled out. See sample sheet. 5. Have teams get their cars from designated area. 6. Tell them they have 10-15 minutes to get their cars ready and to test them. 7. When time is up, have each team present their car to the group and point out features they added to make it go faster or stronger. Have group show their original design drawing and point out what modifications they had to make as they began to construct car. Group may ask questions of each team as they present. 8. Have students bring their cars to the speed ramp. 9. Allow students 1 practice run before getting their actual time. 10. Tell students to record each team's time on their MESA Mousetrap Car Speed Competition handout. 11. Discuss winning cars design. What features made it go the fastest? Discuss with group. 12. Move onto the Incline competition. 13. Allow students 1 practice run. 14. As each team gets their run, have teams record distance onto their MESA Mousetrap Car Power Competition handout. Measure in cm and convert to m. 15. Discuss winning cars design. What made it go the furthest up an incline? What could they have done to their car to make it better? 16. Review types of forces that acted on their cars. Ask each team, what did you do to your car to try to overcome the force of friction? What did you do to your car to help it against gravity? 17. Clean up.
Closure	<ol style="list-style-type: none"> 1. Pass out MESA Notebook to each student and have them copy the following terms into the 'key terms' section: Speed, Velocity, Acceleration, Force, Friction, and Gravity. 2. Discuss each term as it applies to the activity and come up with a group definition for each. Make sure students can apply the definition to their experience with their mousetrap cars.

	<p>3. Tell students they have the remainder of the time to complete the MESA Notebook. They may work with their team. Write the following 'conclusion' questions on the board and tell them to answer it using what they have learned from the activity:</p> <ul style="list-style-type: none"> • <i>How do Newton's 3 Laws of motion affect the motion of my mousetrap car?</i> • <i>What kind of modifications can I make to a car that will address the forces of friction and gravity?</i> • <i>If I could do this activity again, what changes would I make to my car to make it more competitive?</i> <p>4. Monitor their progress.</p> <p>5. Students may complete their MESA Notebook at home.</p>
Informal Assessment	<ul style="list-style-type: none"> • Monitor students as they progress through the project • Monitor students to check for understanding periodically • Informal Oral Presentation of team design and car
Formal Assessment	<ul style="list-style-type: none"> • Completed Mousetrap Car Design • Completed Mousetrap Car • Completed MESA Notebook
Extensions	<ul style="list-style-type: none"> • Math: Use graph paper to graph each team's speed
Trouble Shooting	<ul style="list-style-type: none"> • Have materials ready before students come to the meeting • Email students after meeting 1 and before they come to meeting 2 to remind them to bring their materials. • Have additional mousetraps in case of breakage. • Make sure all students participate in clean up.

Objects keep on doing what they're doing.



First Law of Motion



According to Newton's first law...

An object at rest will remain at rest unless acted on by an unbalanced force. An object in motion continues in motion with the same speed and in the same direction unless acted upon by an unbalanced force.

This law is often called "the law of inertia".

What does this mean?

This means that there is a natural tendency of objects to keep on doing what they're doing. All objects resist changes in their state of motion. In the absence of an unbalanced force, an object in motion will maintain this state of motion.

This law is the reason why you should always wear your seatbelt.

**MORE MASS MEANS
MORE FORCE NEEDED
TO ACCELERATE**



Second Law of Motion



According to Newton's second law...

Acceleration is produced when a force acts on a mass. The greater the mass (of the object being accelerated) the greater the amount of force needed (to accelerate the object).

What does this mean?

Everyone unconsciously knows the Second Law. Everyone knows that heavier objects require more force to move the same distance as lighter objects.

However, the Second Law gives us an exact relationship between force, mass, and acceleration. It can be expressed as a mathematical equation:

$$**F = M A**$$

or

FORCE = MASS times ACCELERATION

This is an example of how Newton's Second Law works:

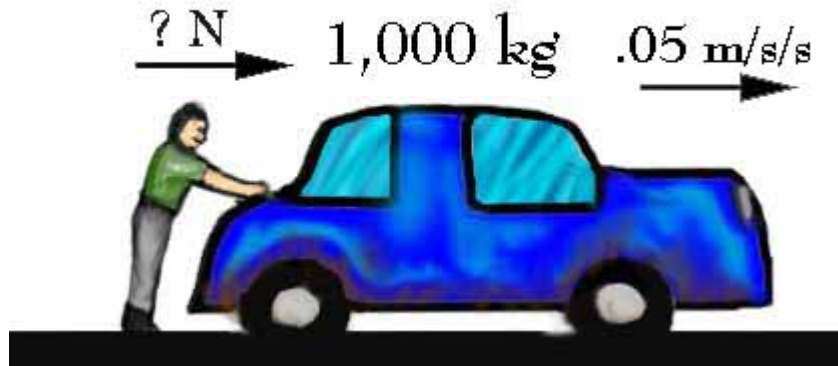

Mike's car, which weighs 1,000 kg, is out of gas. Mike is trying to push the car to a gas station, and he makes the car go 0.05 m/s/s. Using Newton's Second Law, you can compute how much force Mike is applying to the car.

$$**F=1,000 X 0.05**$$

Answer = 50 newtons



Third Law of Motion



According to Newton's third law...

For every action there is an equal and opposite re-action.

What does this mean?

This means that for every force there is a reaction force that is equal in size, but opposite in direction. That is to say that whenever an object pushes another object it gets pushed back in the opposite direction equally hard.

Let's study how a rocket works to understand Newton's Third Law.

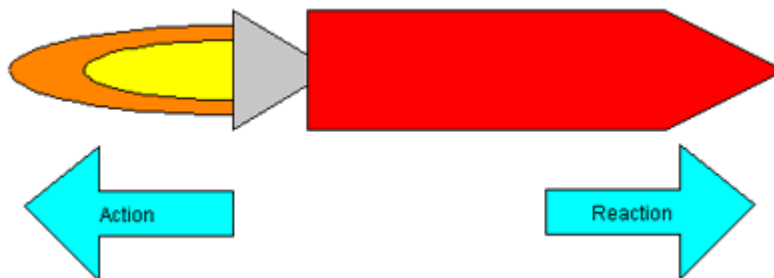

The rocket's action is to push down on the ground with the force of its powerful engines, and the reaction is that the ground pushes the rocket upwards with an equal force.

Source: <http://teachertech.rice.edu/Participants/louviere/Newton/>

Types of Forces

Define the following terms in your own words and try to give examples.

- Gravity:

- Friction:

- Air Resistance:

- Pressure:

Can you come up with other examples?

Mousetrap Car

Competition

Goal:

Each team will build one mousetrap car. It must be powered by the mousetrap mechanism and be built to perform the following tasks:

- Speed: Travel 10 meters in the shortest time
- Power: Travel the furthest distance up a 30 degree incline ramp

Materials:

Design Drawing

- Drawing paper
- Colored Pencils

Mousetrap Car

- One standard mousetrap (provided by advisor)
- Any materials decided upon by each team
-

Instructions:

Day 1:

1. Design your mousetrap car with your team.
2. Draw your design on the drawing paper provided by your advisor. Use colored pencils.
3. Your drawing must show what types of materials are being used in your car.
4. Your drawing must show how friction is acting on your car.
5. Your drawing must show how gravity is acting on your car.
6. Get final approval from your advisor.

Day 2:

1. Check to make sure your team has all the materials needed for your car. If not, you need to modify your drawing.
2. Build your car with your team.
3. Test your vehicle if time permits.

Day 3:

1. Competition day! Follow your teacher's instructions for competition participation.

Rules:

1. The mousetrap car must be solely powered by the mousetrap and activated by tripping the original mousetrap trip mechanism.
2. No other energy source may be added to make the car move. (CO₂, batteries, elastic strings, rubber bands, ect..)
3. The mousetrap must be mounted to the chassis.
4. Hardware and other materials may be added to the mousetrap, but the original hardware and mounting block may only be altered to attach it to the vehicle.
5. The mousetrap may not be disassembled and then reassembled.
6. The springs on the mousetrap may not be cut, bent, overwound, heat treated, or altered in any other manner.
7. No part of the vehicle may be attached to any part of the track or ramp.
8. Vehicle must roll or coast along track or ramp.
9. All wheels must stay in contact with the surface of the track and ramp.

Good Luck and Have Fun!

Pasta Bridge

Objective: Students will be able to build a bridge out of pasta that must span a gap of 20 cm, and have the greatest strength to mass ratio.

Team Member: 2-4

Approximate Total Time: 70 minutes

Materials:

- Lasagna – 1 box per group
- Spaghetti – 1 box per group
- Ruler (for measuring only. Cannot be part of bridge) – 1 per group
- Pencil (for marking only. Cannot be part of the bridge) – 1 per group
- Plastic Pail with handle– 1 total
- Twine – 1 spool
- Scale in grams. Accurate to .01 gram
- Weights of equal measure in grams.

Rules:

1. Students will have one hour to build their bridge. All bridges will be collected and secured at the end of the hour.
2. The bridge may only be constructed using pasta. No other materials or substitutions will be allowed.
3. The bridge must be between 2 and 9 cm wide.
4. The top of the bridge must have a flat test area (6.5 by 9.5 cm) in order to place the testing bucket on the bridge.

Testing:

1. Weight the bridge. Record weight and place over 20 cm span.
2. Bridges must hold a minimum of 1,000 grams (approximate weight of testing bucket) before weights are incrementally added.
3. Winner will be determined by its strength to mass ratio.
4. In the case of a tie, the lightest bridge will win.

Procedures:

Intro: Divide students into groups. Tell students that they will be doing a civil engineering type activity. Explain problem and distribute materials. Set timer and begin. A great resource is <http://www.online-stopwatch.com/> It has a countdown timer that can be set. This way students can see how much time is remaining.

Activity: Allow students to work in their groups. Let the students work to build their bridges. Monitor the activity but do not give students hints. Allow them to explore their ideas. When the hour has passed, have the students place their bridges in a spot close to the testing area. Weigh each bridge and test the capacity. Have students record the Mass and Mass Supported on the Pasta Bridge Score Sheet. Determine the winner by largest score

Closure: Have students discuss what worked and what didn't work. If they could, what changes would they make?

Explain that they have just informally completed the Engineering Design Process. The students explored the problem, designed and built their solution, and then tested it. The questions at the end lead them back through the cycle by having them explore their solutions and decide the strong pieces and the pieces that they noticed failed.

******* This is a great activity to do again in a month or so to lead into the discussion about using the Engineering Notebook to record your work. Students will remember the activity but not the results and outcomes from the discussion.**

Pasta Bridge Score Sheet

Student Name(s): _____

Design Specifications:

Weight of Pasta Bridge: _____ g

Weight Supported by Bridge: _____ g

Calculation of the Strength to Mass Ratio:

$$\frac{\textit{Mass Supported}}{\textit{Mass of Bridge}} = \frac{\textit{g}}{\textit{g}} = \boxed{}$$

Puzzle Cube Challenge

Objective: Students will be able to create a puzzle cube measuring 3x3x3 cubes made from Snap Cubes.

Team Members: 2-4

Approximate Total Time: 60-70 minutes

Materials:

- Snap Cubes (27 per group) – Snap cubes can be found in most math classrooms
- Pre-made puzzle cube
- Pencil
- Engineering Notebook

Rules:

1. The cube must be made from 5 distinct pieces.
2. Each of the 5 pieces must contain 3-6 cubes.
3. No 2 pieces may be exactly the same.
4. The pieces must fit together to make a 3x3x3 cube. The final shape must be a perfect cube.

Teacher Prep: This project has been done in a variety of forms in many places. Some good places to find examples:

<http://meganmccconnell.weebly.com/puzzle-cube.html>

<http://ianwaggoner.weebly.com/puzzle-cube.html>

Both projects incorporate the use of CAD software and a finished product. Our goal here is to get students to work in teams to create concept sketches and then a prototype of the project.

Before you do this problem, build a puzzle cube to show the students what it needs to look like. Try to make the pieces of the same color Snap Cubes so students can see how they fit together and the differences in the 5 pieces that you create.

Intro: Tell the students that they are going to be building a puzzle cube. They will work with a team to first create the concept sketch of what they want it to be. Next, they will be given the materials needed to build and test their puzzle. Have students get into teams. Show the students the puzzle that you have created previously. Describe the process to them. Tell them that they must first design their puzzle as a team and then build it. Tell them they may only build once you have seen their design sketches.

Activity: Students work in teams to design their puzzle. Students will need to draw their concept sketches and decide which designs they think will work the best. Once they have

agreed on the 5 pieces, they must show you their drawings before they can build. The students will build their puzzle cube. Once they are done, have them give it to someone not on the team to test it out. If there is time, challenge the students to make a more complicated cube.

Closure: Talk to students about the importance of having a design sketch before building. The sketch helps to get their ideas organized and provides a starting point. An engineer will create concept sketches before building to make sure they know what materials they need and how they will work together. Strongly encourage the students to design sketch before they build as it will save time, headaches, and having to start a project over when something doesn't work.

Activity #3: Delta II Launch: Out of This World

Background:

Getting from Earth to Mars is not easy! Not only do we have to find a way to give the spacecraft enough energy to leave the Earth's surface, we also have to give it enough energy to leave the influence of the Earth's gravity entirely. When the spacecraft arrives at Mars, even more energy is needed to slow it down so that it can land safely on the surface of the planet. Just giving the spacecraft enough energy isn't enough, however. We also have to make certain that the spacecraft manages to hit its target! Trying to navigate to Mars with a spacecraft is like trying to roll a quarter into a slot one hundred yards away. The slightest error in the launch trajectory turns into a rather spectacular miss at the end of the spacecraft's journey! Energy to lift the spacecraft to Mars and guidance to ensure the spacecraft arrives on-target are the two biggest challenges in getting to Mars.

Currently, the only way to provide a spacecraft with enough energy to reach Mars is to use chemical-fueled rocket boosters. The primary booster currently used by NASA is the Boeing Delta II, a forty-meter (131 feet) long rocket capable of generating 485,700 newtons (109,135 pounds) of thrust. This powerful thrust allows the rocket to reach a maximum speed of over 28,000 km/hr (17,400 mph), which is fast enough to completely escape the gravitational influence of the Earth. Sophisticated on-board and ground-based computers monitor the spacecraft's trajectory to ensure that the spacecraft arrives safely at Mars. The rocket's sensors take in data that allows its processor to determine the rocket's current position. If a course correction is necessary, ground controllers on Earth can instruct the rocket's processor to fire its thrusters (which are actuators) to make the change. Because of fuel limitations, however, only very small corrections can be made in the trajectory of the spacecraft – it is critical that the rocket be on the correct path right from launch!

In this activity your students will be introduced to the energy and guidance problems that are faced by NASA engineers every time they send a rocket into space. They will be tasked with launching a payload (using a rubber band-powered "launcher") from a starting base and having the payload successfully "land" at a predetermined landing site. The students will have to carefully adjust the energy imparted to their "spacecraft" and will also have to consider how they will control the craft so that it arrives on target.

[NOTE: The projectiles used by the students in this activity are not true "rockets" because they do not get their thrust from the application of Newton's Third Law of Motion. The key factors in this activity, energy and guidance, are the same, however.]

Objectives:

Using the results of their experiments, students will create graphs of physical variables and will use these graphs to successfully hit a pre-determined target with a projectile propelled by their launchers.

Grade Levels: 5-12

Time Frame: Approximately two to three 45-minute class periods

Materials Needed (per team of 4 students):

- Rubber bands
- Wooden dowels (or unsharpened pencils)
- Craft sticks
- Small ball
- Target
- Measuring tape
- White glue
- Graph Paper

Optional Materials:

- Small cylinder
- Net

National Science Education Standards

- Content Standard B: Motions and Forces
- Content Standard E: Abilities of Technological Design
- Content Standard E: Understandings about Science and Technology

Procedure:

- Mark off a “launch area” and a “landing site” in an area clear of obstructions and passers-by. Mark off “warning areas” to either side of the “test range” to ensure the safety of participants and observers.
- Pass out the materials to each team. Instruct the students that they are to build a launcher that can propel their “spacecraft” (the ball) into the air and hit the “landing site”.
- Students are free to construct any kind of launcher they wish. The key factor is that the amount of force applied to the ball must be repeatable so that the target can be hit consistently. The launcher should allow for variable amounts of energy to be imparted to the ball and must be able to be positioned in such a way that it can provide the guidance needed to ensure the ball hits the target. Catapults, slingshots, and ramp launchers are very common solutions to these problems. Allow your students to use their own creativity, but if they seem at a loss for ideas, suggest one of these.
- Students should mark their launchers in such a way that the energy imparted can be recorded (at least abstractly). For example, a catapult launcher may have notches numbered from 1 to 5; a slingshot launcher may have actual distances which the rubber band is pulled back marked.
- Similarly, students should mark their launchers in such a way that the direction of launch can be recorded. A simple way is to mark angles on the floor with tape. The launcher’s direction can be recorded by referencing these marks. Note that very few launchers will throw the projectile exactly straight, so some offset is almost always required.

- The students should conduct tests of their launcher at various energies and angles so that they can predict where the projectile will land under any combination of conditions.
- Students will plot their test results on graph paper and will use these graphs to predict the energy and guidance settings needed to hit the final target site.
- During the final launch, students will be given one chance to hit the target. The distance the spacecraft lands from the target site will serve as the evaluation of their measurement and test skills. Note that the students should be able to determine the proper position and energy values for any target distance from their graphs, even if they never actually conducted a test at that distance!
- At your option, use a net at the target site to catch the projectile. This simulates the force applied by “aerobraking” upon arrival at Mars.
- As an option, students could use a cylinder with cardboard fins. This brings the guidance problem to a whole new level, as the students must now also design a spacecraft that is aerodynamically stable!

Assessment:

The students will submit their graphs detailing the results of their tests on their launcher and demonstrating their mastery of the measurement and design processes required. They will demonstrate their understanding of these graphs by using them to determine the position and energy needed for their final launch.

Vocabulary:

- Newton
- Trajectory
- Guidance

Age-Level Adaptations/Extensions:

- For younger students, you should consider restricting them to a single type of launcher and having them control for a single variable (energy). In this case you could either make the target area considerably bigger, or have the students strive to hit a particular distance, rather than distance and position.
- Older students could use weights to measure the force needed to pull the rubber bands back a certain distance. Using these measurements in their proper units, students can plot the actual force vs. distance on their graphs instead of using the abstract measurements (“notch 1”, “notch 2”, for example) described above.

“High-Tech” Adaptations/Extensions:

- This activity is perfectly suited for using chemical-powered model rockets. Each model rocket engine lists its rated thrust in newtons along with its burn time and coast time. Students can strive for altitude and the ability to hit a specific target upon recovery via parachute. Many different curricula are available for this basic task, including software that will graphically simulate the model rocket’s flight through the atmosphere – a very realistic and cost-effective way to conduct a test program!

Credits: Keith Watt, M.A., M.S.
ASU Mars Education Program
Mars Space Flight Facility
Arizona State University
marsed@asu.edu
(480) 965-1788

Roller Coaster – High School

Objective: Students will be able to

- Use the Law of Conservation of Energy to explain the layout of a roller coaster
- Explain how a roller coaster works in terms of physics concepts
- Design and build a roller coaster

Team Members: 2-4

Time Frame: 2 days, each day taking 60-80 minutes

Materials:

- Engineering Design Notebook
- Assorted materials such as popsicle sticks, pipe cleaner, cardstock, paper towel rolls, empty 2-liter bottles, tubes, scissors, glue, tape. Whatever materials you decide to use. Cafeterias are a great place to find a lot of fun things for this project.
- Marbles – 1 per group
- Drawing paper
- Colored pencils
- Meter stick – 1 per group
- Stopwatch

Procedure – Day 1:

Intro: Ask the students about their experiences with roller coasters. Or, show a video of a roller coaster. https://youtu.be/h_lcZcBcQ0o This a fun one to watch from different perspectives. Do the students love or hate them? Why? Have the students share their thoughts and experiences with roller coasters.

Activity: Ask the students if they understand how roller coasters work. Guide students to understand that roller coasters are powered by gravity. Make sure that students have a good understanding on gravity and what it is.

Ask students to think about what is common in roller coasters. [They are pulled up a track to start the ride. It is always the highest track.] Why do they start this way? What does this do? [Going to the top of the hill provides the greatest potential energy to finish the rest of the track.] The roller coaster has the greatest potential energy the higher it starts.

The roller coaster is called a roller coaster because it uses all the potential energy to “coast” along the track. Lead a discussion with the students to get them to this point. Ask leading questions like “Why is a roller coaster called a roller coaster?” “What does coasting have to do with the discussion about energy?” Lead students to the point where they understand that the

“car” is coasting along the track, converting energy to kinetic from potential and vice versa. Have this conversation lead into the Law of Conservation of Energy. Vanderbilt has a great gif about roller coasters and the conservation of energy. Make sure students understand what it is. [energy cannot be created or destroyed; it can only be transformed (changed from one type to another) or transferred (from one object to another)]. The roller coasters energy at the highest hill is transformed from potential (going up the hill) to kinetic (going down the hill). Each rise/fall is a transformation of energy.

Move into a conversation about friction. How does friction affect the energy of the roller coaster? Make sure students understand friction [the resistance of one object moving against another] and how that can affect the roller coaster. This is why the first hill has to be the highest. Friction will transform some of the kinetic energy into heat. So, the Law of Conservation of Energy still applies. The roller coaster loses some of the kinetic energy when it is transformed into heat because of the friction.

Ask the students about the difference between acceleration and velocity. [Velocity is the speed of the object. Acceleration is the change in velocity.] How do we experience acceleration? [We are pushed back with positive acceleration, pushed forward by negative acceleration]. We move in the opposite direction because of inertia. This is a good place to remind students of Newton’s First Law [A body in motion will tend to stay in motion, a body at rest will tend to stay at rest] and how acceleration plays a role in that. It is the inertia that will keep people from falling out of a roller coaster. It is creating centripetal force (moving away from the center of a circle) that holds the roller coaster in place. An easy example is to swing a cord over your head (maybe a lanyard). The motion will push the end away from the center of the circle.

The acceleration on the roller coaster provides the thrill elements. The acceleration down the hill, the centripetal force of a turn, a loop the loop; all these elements involve acceleration and makes the thrill elements that are part of your coaster.

Now that you have finished the conversation about the physics of the coaster, have the students start designing their own. Hand out the “Design a Roller Coaster” handout and let the students get to work. Today is about the designing. Make sure that the students know that the marble will be the “car” and will travel the track. The next session will be about the building and testing. Tell students that they can bring materials from home.

Closure: Have students store their designs/notebooks in a safe place. Let them know that the next meeting will be the building/testing of their design. Have a debrief of how the designing went. Get them excited to build for the next meeting. Remind students that they can bring materials from home.

Procedure – Day 2:

Pre-Activity: Have the materials out and ready for student use. Have space available for students to build.

Intro: Remind students what they are doing. Give them 5 minutes to gather their notebooks/drawings and supplies. Tell teams to look at their designs and see if they need to make any modifications based on what materials are present.

Activity: Have the students work for 40 minutes to build and test their design. Monitor their progress and make suggestions as you see fit. Make sure the students are testing their designs and making the necessary modifications. When the 40 minutes are up, have teams show off their roller coasters with a walking tour.

Closure: Ask the students which ones they liked and why. Ask if they would make any modifications and why they would make them. Have the students clean up.

Design a Roller Coaster Competition

Goal:

Your mission is to design a roller coaster that satisfies the specifications below. In teams of three or four, you will first draw your design on paper. If you are not sure if something will work, try it out with materials like paper, cardstock and masking tape. Once you have a final design, have your advisor approve it and you can start building with materials of your choosing. Choose your materials wisely, and BE CREATIVE!

Roller Coaster Specifications:

- Fit within a 70x70x70 cm³ space and weigh no more than 10 kg
- Have at least 2 thrill elements
- Keep contact with the marble at all times
- Consist of a ride of 10 - 25 seconds, more points for longer rides without going over
- Get the marble to a complete stop at the end

Treat the marble like a car full of people - make sure it reaches the end of the track safely! Don't allow the marble to do anything that roller coaster designers wouldn't allow with people: no flying through the air, crashing, etc.

Team Materials:

Design Drawing

- Drawing paper
- Colored Pencils

Roller Coaster

- One marble (provided by advisor)
- Meter stick
- Stopwatch
- Any materials decided upon by each team

Instructions:

Day 1:

1. Design your roller coaster with your team.
2. Draw your design on the drawing paper provided by your advisor. Use colored pencils.
3. Your drawing must show what types of materials are being used in your design.
4. Identify on your drawing the place where the roller coaster will experience the maximum potential energy.
5. Identify on your drawing the place where the roller coaster will experience the maximum kinetic energy.
6. Identify on your drawing any place where the roller coaster experiences a centripetal force, and draw an arrow indicating the direction of that force.
7. If there are any components you want to test out before you prepare your final design, take some time to use the materials set out by your instructor to construct a model to test.
8. Have your advisor approve your design before you build your final design.
9. Be creative

Day 2:

1. Check to make sure your team has all the materials needed for your roller coaster. If not, you need to modify your drawing.
2. Build your roller coaster with your team.
3. Test your roller coaster with any remaining time.

Roller Coaster – Middle School

Objective: Students will be able to

- Use the Law of Conservation of Energy to explain the layout of a roller coaster
- Explain how a roller coaster works in terms of physics concepts
- Design and build a roller coaster

Team Members: 2-4

Time Frame: 2 days, each day taking 60-80 minutes

Materials:

- Engineering Design Notebook
- Assorted materials such as popsicle sticks, pipe cleaner, cardstock, paper towel rolls, empty 2-liter bottles, tubes, scissors, glue, tape. Whatever materials you decide to use. Cafeterias are a great place to find a lot of fun things for this project.
- Marbles – 1 per group
- Drawing paper
- Colored pencils
- Meter stick – 1 per group
- Stopwatch

Procedure – Day 1:

Intro: Ask the students about their experiences with roller coasters. Or, show a video of a roller coaster. https://youtu.be/h_lcZcBcQ0o This a fun one to watch from different perspectives. Do the students love or hate them? Why? Have the students share their thoughts and experiences with roller coasters.

Activity: Ask the students if they understand how roller coasters work. Guide students to understand that roller coasters are powered by gravity. Make sure that students have a good understanding on gravity and what it is.

Ask students to think about what is common in roller coasters. [They are pulled up a track to start the ride. It is always the highest track.] Why do they start this way? What does this do? [Going to the top of the hill provides the greatest potential energy to finish the rest of the track.] The roller coaster has the greatest potential energy the higher it starts.

The roller coaster is called a roller coaster because it uses all the potential energy to “coast” along the track. Lead a discussion with the students to get them to this point. Ask leading questions like “Why is a roller coaster called a roller coaster?” “What does coasting have to do with the discussion about energy?” Lead students to the point where they understand that the

“car” is coasting along the track, converting energy to kinetic from potential and vice versa. Have this conversation lead into the Law of Conservation of Energy. Vanderbilt has a great gif about roller coasters and the conservation of energy. Make sure students understand what it is. [energy cannot be created or destroyed; it can only be transformed (changed from one type to another) or transferred (from one object to another)]. The roller coasters energy at the highest hill is transformed from potential (going up the hill) to kinetic (going down the hill). Each rise/fall is a transformation of energy.

Move into a conversation about friction. How does friction affect the energy of the roller coaster? Make sure students understand friction [the resistance of one object moving against another] and how that can affect the roller coaster. This is why the first hill has to be the highest. Friction will transform some of the kinetic energy into heat. So, the Law of Conservation of Energy still applies. The roller coaster loses some of the kinetic energy when it is transformed into heat because of the friction.

Ask the students about the difference between acceleration and velocity. [Velocity is the speed of the object. Acceleration is the change in velocity.] How do we experience acceleration? [We are pushed back with positive acceleration, pushed forward by negative acceleration]. We move in the opposite direction because of inertia. This is a good place to remind students of Newton’s First Law [A body in motion will tend to stay in motion, a body at rest will tend to stay at rest] and how acceleration plays a role in that. It is the inertia that will keep people from falling out of a roller coaster. It is creating centripetal force (moving away from the center of a circle) that holds the roller coaster in place. An easy example is to swing a cord over your head (maybe a lanyard). The motion will push the end away from the center of the circle.

The acceleration on the roller coaster provides the thrill elements. The acceleration down the hill, the centripetal force of a turn, a loop the loop; all these elements involve acceleration and makes the thrill elements that are part of your coaster.

Now that you have finished the conversation about the physics of the coaster, have the students start designing their own. Hand out the “Design a Roller Coaster” handout and let the students get to work. Today is about the designing. Make sure that the students know that the marble will be the “car” and will travel the track. The next session will be about the building and testing. Tell students that they can bring materials from home.

Closure: Have students store their designs/notebooks in a safe place. Let them know that the next meeting will be the building/testing of their design. Have a debrief of how the designing went. Get them excited to build for the next meeting. Remind students that they can bring materials from home.

Procedure – Day 2:

Pre-Activity: Have the materials out and ready for student use. Have space available for students to build.

Intro: Remind students what they are doing. Give them 5 minutes to gather their notebooks/drawings and supplies. Tell teams to look at their designs and see if they need to make any modifications based on what materials are present.

Activity: Have the students work for 40 minutes to build and test their design. Monitor their progress and make suggestions as you see fit. Make sure the students are testing their designs and making the necessary modifications. When the 40 minutes are up, have teams show off their roller coasters with a walking tour.

Closure: Ask the students which ones they liked and why. Ask if they would make any modifications and why they would make them. Have the students clean up.

Design a Roller Coaster Competition

Goal:

Your mission is to design a roller coaster that satisfies the specifications below. In teams of three or four, you will first draw your design on paper. If you are not sure if something will work, try it out with materials like paper, cardstock and masking tape. Once you have a final design, have your advisor approve it and you can start building with materials of your choosing. Choose your materials wisely, and BE CREATIVE!

Roller Coaster Specifications:

- Fit within a 70x70x70 cm³ space and weigh no more than 10 kg
- Have at least 2 thrill elements
- Keep contact with the marble at all times
- Consist of a ride of 10 - 25 seconds, more points for longer rides without going over
- Get the marble to a complete stop at the end

Treat the marble like a car full of people - make sure it reaches the end of the track safely! Don't allow the marble to do anything that roller coaster designers wouldn't allow with people: no flying through the air, crashing, etc.

Team Materials:

Design Drawing

- Drawing paper
- Colored Pencils

Roller Coaster

- One marble (provided by advisor)
- Meter stick
- Stopwatch
- Any materials decided upon by each team

Instructions:

Day 1:

1. Design your roller coaster with your team.
2. Draw your design on the drawing paper provided by your advisor. Use colored pencils.
3. Your drawing must show what types of materials are being used in your design.
4. Identify on your drawing the place where the roller coaster will experience the maximum potential energy.
5. Identify on your drawing the place where the roller coaster will experience the maximum kinetic energy.
6. Identify on your drawing any place where the roller coaster experiences a centripetal force, and draw an arrow indicating the direction of that force.
7. If there are any components you want to test out before you prepare your final design, take some time to use the materials set out by your instructor to construct a model to test.
8. Have your advisor approve your design before you build your final design.
9. Be creative

Day 2:

1. Check to make sure your team has all the materials needed for your roller coaster. If not, you need to modify your drawing.
2. Build your roller coaster with your team.
3. Test your roller coaster with any remaining time.

Rube Goldberg Lesson Plan

Written by: Alex Gordon, Lana Nguyen and Lisa Townsend
(contact at lisatownsend@berkeley.edu)
Last Updated: 2/4/11

Introduction/Background Info

Tailor the following information based on the age group/education level. Start with this introduction and make it relevant to their lives. Make sure they understand the unnecessary complexity of a Rube Goldberg machine and why he was doing this.

Simple and compound machines are used to make tasks easier. On the other hand, Rube Goldberg took a simple, easy task and made it more complex. Rube Goldberg was an American cartoonist, sculptor, author, engineer, and inventor. He graduated from UC Berkeley in 1904 with a MSE degree. His cartoons depicted complex machines that would complete a simple task in an indirect and convoluted way such as the one below. He made this to poke fun at other machines that were made overly complicated and could have been done in a much simpler fashion.

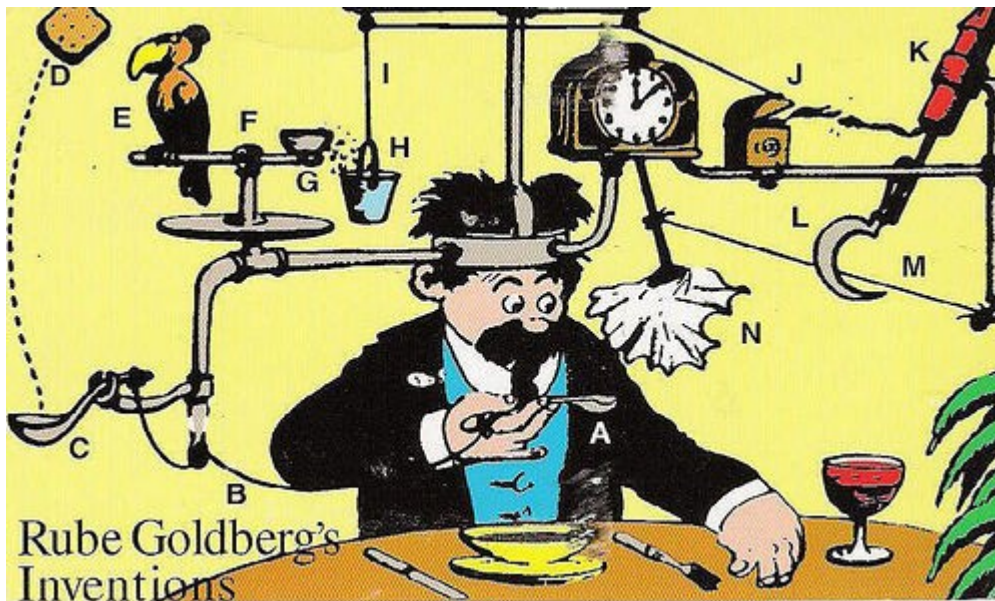

Fig 1. A

Goldberg cartoon of a “self-operating napkin”

Rube

In general engineering, the best design is the simplest design for many reasons. Even in complex machines, the simpler the individual components are, the easier it is to make the machine, the more reliable it is, and the easier the maintenance. One way that engineers assess the usefulness of a machine is its mechanical advantage. *Mechanical advantage* is the number of times a force exerted on a machine is multiplied by the machine. A simple machine that has a mechanical advantage can stand on its own or can be added to other simple machines. When two simple machines are combined, their mechanical advantages are multiplied together, not added. Often times, these machines have a positive and useful meaning in your life.

However, mechanical advantage cannot always be the best way to assess usefulness because a Rube Goldberg machine has a large mechanical advantage, but is overly complex.

What are some examples of machines that you use in your life? [i.e. a bicycle (gets you places), blender (makes you delicious drinks), video games (fun), etc.]

A fun example of a Rube Goldberg machine:

<http://www.youtube.com/watch?v=qybUFnY7Y8w>

And here is one done by MythBuster's:

http://www.youtube.com/watch?v=lCYg_gz4fDo&feature=related

These videos are good to look at for some ideas.

Design Process:

In the process of inventing, there are several steps regardless of the machine.

1. Determine what needs to be accomplished (What is the problem? Who is the device for?).
2. What are the constraints, materials, time allotted, safety, etc? Meet the given specifications.
3. Brainstorm! What simple machines can you use? Write and draw your ideas to save time and materials!
4. Make sure your ideas meet the design requirements. Materials lists are a good idea.
5. Once all the steps above are met, build! Try to utilize materials.
6. Test and troubleshoot!
7. Rebuild!

Student Objectives:

- 1) Understand the basic ideas of machines and mechanical advantages.
- 2) Understand the Engineering Design Process.
- 3) Learn to troubleshoot.

Topic(s):

- Mechanical Advantage – The number of times a force exerted on a machine is multiplied by the machine (mechanical advantage = output/input).
- Simple Machines – Machines that make work easier for people.
- Compound Machine – Two or more simple machines combined together to make one unit or machine to further simplify work.
- Design – To form a plan.
- Specifications – An exact and detailed statement of something to be built.

Overview of Lesson Process:

Example format: If possible, pose a problem with a storyline to make it interesting. For example: the story could be a clinical case where someone comes in with a kidney failure.

- 1) Discuss who Rube Goldberg is and what he did. Talk about his machines.
- 2) Talk about the basics of machines (i.e. mechanical advantage, simple and compound machines).
- 3) Discuss the competition and the guidelines.
- 4) Break up into several teams and get started!
- 5) Review what was learned. Also, go over what worked and what could have been improved.

Materials:

Rubber Bouncy Balls
Paper Cup
Paper clips

String
Cardboard
Straws
Rubber bands
Balloons
Masking Tape
Dominoes (~30 per school)
Mousetraps*

Optional:

Glue gun +Glue sticks
Marbles

*All mousetraps must be monitored by mentors. No setting of traps or triggering of traps are allowed by elementary students. High school students are allowed to handle them, as long as they do so responsibly.

Procedures:

Tips:

- Compartmentalize: phase 1, phase 2, etc then within each phrase you break the procedure down step-by-step.
- Number the steps
- Describe steps in simple words, use pictures and diagrams when you think they are helpful
- Make it as clear as possible.

Phase I

1. Discuss Rube Goldberg and his work.
2. Describe his machines.
3. Talk about the ideas of simple and compound machines and mechanical advantage.
4. Discuss why Rube Goldberg is counter-intuitive.
5. What are some examples of useful machines?
6. Briefly discuss the engineering design process

Phase II

Goal: Pop a balloon.

*Goal of the lesson can be

Guidelines:

- Meet end goal
- At least 4 steps prior to achieving goal (add more steps if time allows)
- Break kids into smaller groups within teams to build simple machines that can flow together.
- Have mentors handle hot glue guns.
- Each site leader in charge of getting cardboard.
- Can create mid-way goals (i.e. make a ball into a cup).
- Optional: Bring your own ideas for materials!
- Let the kids' creativity flow! Try not to step in too much!

Example Steps: Swinging ball hits other ball down ramp. This rolling ball hits line of Dominoes. End Domino has paper clip. Falls on balloon and pops it.

Resources

- http://www.teachengineering.org/view_lesson.php?url=http://www.teachengineering.org/collection/cub_/lessons/cub_simp_machines/cub_simp_machines_lesson05.xml
- <http://www.youtube.com/watch?v=qybUFnY7Y8w>

Sail Car

Objective: Students will be able to build a car that will travel the furthest distance using the wind as power. Students will also create a car that uses the least amount of material.

Team Members: 2-4

Time Frame: 60 minutes

Materials:

- Straws (4 per group)
- Plastic water bottle (1 per group)
- Printer paper (4 per group)
- “Wheels” (CDs, DVDs, Nerf discs, anything round) (4 per group)
- Cardboard (approximately 3’ x 3’ square) (1 per group)
- Rubber bands (2 per group)
- Masking tape (3 ft per group)
- Scissors
- Box fan
- Measuring tape
- Stopwatch (www.onlinestopwatch.com is a great resource)

Procedure:

Pre-Activity: Assemble the materials for the groups. CDs and DVDs can usually be found with the Tech person at your site gathering dust. Determine where you are going to test the vehicles and have your box fan ready and plugged in. Make sure the track is clear of any debris or desks.

Intro: We are always looking for alternate ways to power a vehicle. We are also looking for ways to reduce cost. Today, you are going to build a car using the least amount of materials. The car must be moved by the fan. The car that travels the furthest will be the winner. In the event of a tie, the car that used the least amount of material will be the winner. You will have 40 minutes at most to design, build, and test your car before competition.

Activity: Hand out the materials and let the students get to work. Monitor the groups and make notes of the different designs and ideas. Clarify any questions but let the students work on their own. If students want to test their prototypes, allow them to. Students may not get any more materials. They may only use the materials they are given. When the time is up, have the students bring their cars to the testing area. Test and measure the distance each car travels. Announce the winner and have students clean up any mess.

Closure: Ask students what worked. Make sure to point out any interesting features you saw during your walk around. Talk to students about the need for alternative energy sources and that innovation is what they are building is essential in today’s world.

Taken from egfi.org

Summary

Working in groups of three, high school students use their understanding of projectile physics and fluid dynamics to calculate the water pressure in squirt guns by measuring the range of the water jets. They create graphs to analyze how the predicted pressure relates to the number of times they pump the water gun before shooting.

Grade level: 9-12

Time: 120 minutes

Cost: \$2 per group

Learning Objectives

After this activity, students should be able to:

- Use projectile motion physics to determine the initial velocity of a projectile launched horizontally.
- Use Bernoulli's equation to find the pressure of a fluid.
- Collect, record, and analyze data to determine relationships among variables.

Learning Standards

Common Core State Math Standards

- Create equations that describe numbers or relationships. Rearrange formulas to highlight a quantity of interest, using the same reasoning as in solving equations. For example, rearrange Ohm's law $V = IR$ to highlight resistance R .
- Solve linear equations and inequalities in one variable, including equations with coefficients represented by letters.
- Represent and solve equations and inequalities graphically. Understand that the graph of an equation in two variables is the set of all its solutions plotted in the coordinate plane, often forming a curve (which could be a line).
- Solve equations and inequalities in one variable.

Next Generation Science Standards

Create a computational model to calculate the change in the energy of one component in a system when the change in energy of the other component(s) and energy flows in and out of the system are known. [9 – 12]

International Technology and Engineering Educators Association

Energy cannot be created nor destroyed; however, it can be converted from one form to another. [9-12]

Engineering Connection



When engineers design water amusement park rides, water fountains, or anything that involves shooting water, they use a similar modeling process to determine where water jets will land. This ensures the safety and best experience for its users. More generally, Bernoulli's equation is used by any engineer working with fluids. For example, biomedical engineers use this principle to model the flow and pressure of bodily fluids, and civil engineers use it to determine the size of pipes needed to get water to people's homes and workplaces, or to run industrial processes.

Materials List

For each group:

- Water gun with a pumping mechanism (for example, Super Soaker Water Blasters; available at stores such as Target, Kmart, WalMart or online; ~\$10 each); ask students to bring in their own, if possible
- Moveable desk or table, on which to mount the water gun
- Duct tape
- Access to a tape measure long enough to measure 35+ feet (11+ meters), the shot distances
- (optional) Chalk or tape, to mark off every 10 meters of the shooting range
- Pen or pencil
- [Take Your Best Shot Worksheet](#), one per person
- [Evaluation & Enhancement Worksheet](#), one per person
- (optional) Computers and Excel spreadsheet software for data manipulation and graphing

Introduction/Motivation

Nothing is better on a hot summer day than the thrill of a fast, steep ride at a water park. To make that ride both fun and safe, engineers must predict how fast people will move, what the forces on their bodies will be, and where they will land. Fortunately for you, projectile motion

physics and fluid mechanics provide the equations they need to determine these variables. Today we'll see how.

Procedure

Bernoulli Equation: The Bernoulli equation is an important expression that relates pressure, height and velocity of a fluid at one point along its flow. According to the Venturi Effect, a fluid's pressure decreases as its velocity increases. The Bernoulli equation puts this relationship into mathematical terms and includes a term for fluid height. Think of water moving down a water slide. At the top (where you load), the water is slow moving, pushed only by the water behind it. When the slide drops, the water rushes down quickly, increasing speed as it falls. Thus, the velocity is also affected by gravity through height. When all these terms are related and scaled for density and gravity, we have the Bernoulli equation,

$$\frac{1}{2}\rho v^2 + \rho g z + P = \text{constant} \quad (1)$$

Equation 1

where v is fluid velocity, ρ is fluid density, z is relative height, and P is pressure. Notice the constant has units of pressure as well.

Derived from energy conservation, the Bernoulli equation tells us that the sum of the kinetic and potential energy at any point along a streamline must remain constant. Technically, the equation only applies to the case of flow that is steady (not changing), has constant density, and is inviscid. Many fluids (such as the water in a squirt gun) approximate these conditions, making Bernoulli's equation a useful model.

Finding the Pressure in a Water Gun: Students are asked to use the equations of projectile motion, combined with Bernoulli's equation to find the water pressure. This section explains how to arrive at the solution, if you'd like to give students more guidance. Bernoulli's equation can determine the pressure inside the water gun, but first you have to know how fast the water coming out of it is moving. Kinematics physics equations can help us find the velocity of the water.

As the water leaves the water gun, it is travelling entirely in the horizontal direction, so its total velocity vector can be reduced to horizontal velocity, or V_x . A simple relationship relates the horizontal velocity (V_x) to the distance (x) it travels in a certain amount of time (t),

$$x = v_x \cdot t \quad (2)$$

Equation 2

The distance can be measured, but unfortunately, we do not know time. However, we can determine the time using another kinematic equation that relates time to the initial and final vertical positions of the water (y_0 and y_f), the initial vertical velocity (v_{y0}), and the vertical acceleration, a_y ,

$$y_f = y_0 + v_{y0}t + \frac{1}{2}a_y t^2 \quad (3)$$

This equation simplifies greatly under the initial conditions set by this problem. The initial vertical position of the water (y_0) is the table, and the final position (y_f) is the floor, so $y_f - y_0$ is simply the height of the table, or h . As we already said, the initial velocity of the water is directed horizontally, making the initial vertical velocity, v_{y0} , equal to zero as well. Finally, the vertical acceleration is g , or -9.8 m/s^2 , the constant acceleration due to gravity. The equation simplifies to

$$h = -\frac{1}{2}gt^2 \quad (4)$$

Equation 4

Using algebra, we can solve for time, and then plug the result into Equation 2 to solve for velocity.

Once velocity is found, we can solve for pressure using Bernoulli's equation. Because the Bernoulli equation equals the same constant at all points along a streamline, we can set the Bernoulli equation at two points equal to each other and use information on the system at one point to solve for information at another, as shown in the equation below:

$$\frac{1}{2}\rho v_1^2 + \rho gh_1 + P_1 = \frac{1}{2}\rho v_2^2 + \rho gh_2 + P_2 \quad (5)$$

Equation 5

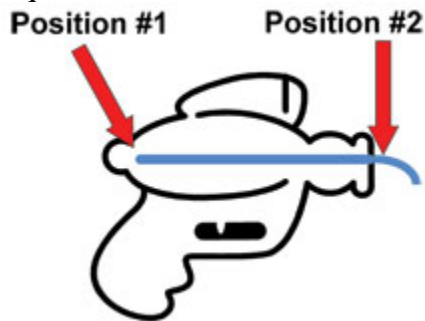

To solve for the pressure, two useful points to choose are the inside of the water gun (position #1) and the outside of the gun at the nozzle (position #2) because we know some of the quantities at these locations.

Copyright © 2009 ITL Program, College of Engineering, University of Colorado at Boulder.

For this **particular** problem, two useful points to choose are the inside of the gun (position #1) and the outside of the gun at the nozzle (position #2). These points are chosen because we know some of the quantities at these locations. We know that the velocity of the water inside the gun (v_1) is initially zero, and that the pressure outside the gun (P_2) is the atmospheric pressure. The density (ρ) is the density of water, and the relative heights (h_1 and h_2) are equal because we are keeping the gun level. After some algebraic manipulation, the pressure inside the water gun is easily solvable.

Before the Activity

- Gather materials. If possible, ask students to bring their own super soaker water guns from home.
- Make copies of the [Take Your Best Shot Worksheet](#) and the [Evaluation & Enhancement Worksheet](#).
- Find an appropriate location to shoot the squirt guns. It is best to secure a relatively open space with access to water and a dry concrete surface (to better see where water lands).
- Set up a table or desk so it is level, and mark off with chalk or tape the distance from the table every meter for ~10 meters.



Copyright © 2009 James Prager, ITL Program, College of Engineering, University of Colorado at Boulder.

Place the water gun on the table, securing it with duct tape if unstable, making sure the nozzle is horizontal and level.

With the Students

1. Conduct a pre-activity assessment discussion with the students, as described in the Assessment section.
2. Have students read the background and procedural instructions on the Take Your Best Shot Worksheet, and set up their experiments.
3. When ready, run the experiments as described in the worksheet.
4. Have the students perform the calculations and graphing on the Take Your Best Shot Worksheet. (Optional: Have them use a digital spreadsheet such as Microsoft Excel for data manipulation and graphing.)
5. Have students complete the Evaluation & Enhancement Worksheet.

Take Your Best Shot Worksheet

Introduction

In this activity, you will be measuring the distance water travels from a squirt (water) gun and comparing that to the number of times you pumped it. You will use this information to calculate the velocity at which the water left the gun. Then, starting with the exit velocity, you will use Bernoulli's equation to calculate the pressure inside the water gun chamber. Finally, you will compare the chamber pressure vs. the number of pumps by plotting the data.

Background and Theory

To determine the pressure inside the water gun, you first need to know how fast the water is coming out of the nozzle. As the water droplets move from the end of the nozzle to the ground, they follow the rules of projectile motion. Using your understanding of these equations, you'll find the initial velocity of the water as it exits the nozzle.

Let's practice one together first. Assume that for your first data point, the height of the table was 0.800 m, and the water travelled 1.50 m from the edge of the table. Find the initial velocity of the water as it leaves the nozzle. Discuss strategies with your group, then show your work in the space below:

Now that you have velocity, you can solve for pressure using Bernoulli's equation. Because the Bernoulli equation equals the same constant at all points along a streamline, we can set the Bernoulli equation at two points equal to each other and use information on the system at one point to solve for information at another.

$$\frac{1}{2}\rho v_1^2 + \rho g h_1 + P_1 = \frac{1}{2}\rho v_2^2 + \rho g h_2 + P_2$$

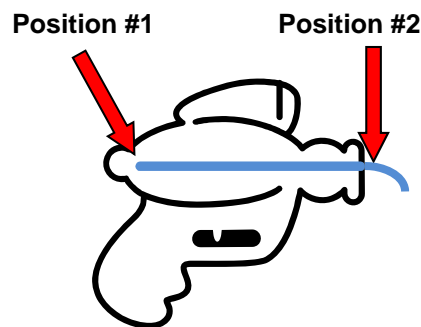

For the example problem given above, find the water pressure inside the gun (P_1). [Hints: We know that the velocity of the water inside the gun (v_1) is initially zero, the pressure outside the gun (P_2) is the atmospheric pressure, or approximately 101,000 Pa, the density (ρ) is the density of water, and the relative heights (h_1 and h_2) are equal because we are keeping the gun level.] Show your work in the space below:

Setup-Aim...

1. Find a location where you have a long, flat space to shoot water. If the weather is nice enough, outside would be ideal.
2. Fill your water gun with water. Pump it a couple of times and shoot it, then top it off. So the water gun works properly, leave a small amount of air in the tank.
3. Mount your water gun on a sturdy surface approximately a meter above the ground. The gun should be mounted on its side and secured with duct tape. Once secured, make sure you can still squeeze the trigger and move the pump.
4. Measure the height of the nozzle above the ground.
5. Make sure to have a tape measure on hand to measure the distance later.
6. Designate one group member to be responsible for marking where the water lands.

FIRE!

1. Pump the water gun the number of times you have decided for your first trial, and shoot the water. Hold the trigger until the water has stopped coming out, to ensure that no pressure is left in the chamber.
2. Measure the distance between the nozzle and where the water lands.
3. Repeat this procedure for each trial.

Data Table

Draw your data table in the space below, and record your data and measurements in the table.

Number of Pumps	Maximum Distance (ft)
1	
2	
3	
4	
5	
6	
7	
8	
9	
10	

Calculations

Using the data you collected and the equations given in the Background and Theory section, solve for the pressure inside the water gun at each pump. To save time, try doing these calculations in an Excel spreadsheet. If you do the calculations by hand, show your work on a separate sheet of paper.

Graphing

On a separate sheet of graph paper, or in Excel, graph the pressure vs. the number of pumps. Also graph the distance the water travelled vs. the number of pumps. What does the graph tell you about the relationship between water pressure and the number of pumps?

Name: _____ Date: _____

Evaluation & Enhancement Worksheet

Error

In this experiment, what do you think some potential sources of error?
How would these affect your results?

What does it all mean?

What do your graphs look like?

Imagine you are an engineer designing the next generation of squirt guns. You want them to shoot further than ever with fewer pumps. How can this data help you in your designs?

Name: _____ Date: _____

Evaluation & Enhancement Worksheet **Answers**

Error

In this experiment, what do you think some potential sources of error?
How would these affect your results?

Non-horizontal gun: Could increase or decrease the distance travelled, lead to an incorrect horizontal velocity and ultimately skewed pressures.

Non-ideal fluid: The fluid (water) is not perfectly inviscid, nor is it purely steady. Therefore, the Bernoulli equation only models the flow approximately.

Non-uniform pumping: Changes the actual pressure each time.

What does it all mean?

What do your graphs look like? Imagine you are an engineer designing the next generation of squirt guns. You want them to shoot further than ever with fewer pumps. How can this data help you in your designs?

This data can help you decide what sort of pressure tolerances your toy should have, as well as how much pressure per pump you should design into the toy.

Take Your Best Shot Worksheet Answers

Introduction

In this activity, you will be measuring the distance water travels from a squirt (water) gun and comparing that to the number of times you pumped it. You will use this information to calculate the velocity at which the water left the gun. Then, starting with the exit velocity, you will use Bernoulli's equation to calculate the pressure inside the water gun chamber. Finally, you will compare the chamber pressure vs. the number of pumps by plotting the data.

Background and Theory

To determine the pressure inside the water gun, you first need to know how fast the water is coming out of the nozzle. As the water droplets move from the end of the nozzle to the ground, they follow the rules of projectile motion. Using your understanding of these equations, you'll find the initial velocity of the water as it exits the nozzle.

Let's practice one together first. Assume that for your first data point, the height of the table was 0.800 m, and the water travelled 1.50 m from the edge of the table. Find the initial velocity of the water as it leaves the nozzle. Discuss strategies with your group, then show your work in the space below:

Teacher note: You may want to give students more guidance on this if their experience with projectile motion is more limited. Using the equations from the activity description, we start with

$$y_f = y_o + v_{yo}t + \frac{1}{2}a_yt^2.$$

Plugging the data in, we have

$$0 = 0.800 + 0 + \frac{1}{2}(-9.8)t^2.$$

$$t = 0.404 \text{ s}$$

This gives us the time that it takes for the water to hit the ground. Plugging this in to equation 2 on the activity description,

$$x = v_x * t$$

$$1.50 = v_x * 0.404$$

$$v_x = 3.71 \text{ m/s}$$

Now that you have velocity, you can solve for pressure using Bernoulli's equation. Because the Bernoulli equation equals the same constant at all points along a streamline, we can set the Bernoulli equation at two points equal to each other and use information on the system at one point to solve for information at another.

$$\frac{1}{2}\rho v_1^2 + \rho gh_1 + P_1 = \frac{1}{2}\rho v_2^2 + \rho gh_2 + P_2$$

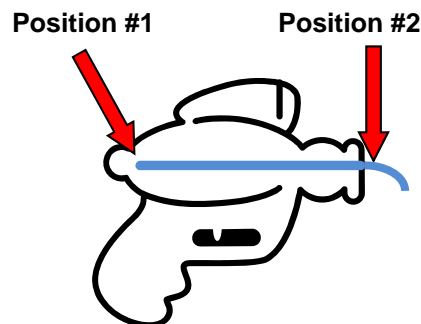

For the example problem given above, find the water pressure inside the gun (P_1). [Hints: We know that the velocity of the water inside the gun (v_1) is initially zero, the pressure outside the gun (P_2) is the atmospheric pressure, or approximately 101,000 Pa, the density (ρ) is the density of water, and the relative heights (h_1 and h_2) are equal because we are keeping the gun level.] Show your work in the space below:

$$\frac{1}{2}\rho v_1^2 + \rho g h_1 + P_1 = \frac{1}{2}\rho v_2^2 + \rho g h_2 + P_2$$

$$P_1 = \frac{1}{2}\rho v_2^2 + P_2$$

$$P_1 = \frac{1}{2} (1000 \text{ kg/m}^3) (3.71 \text{ m/s})^2 + 101,000 \text{ Pa}$$

$$P_1 = 108,000 \text{ Pa}$$

Setup-Aim...

1. Find a location where you have a long, flat space to shoot water. If the weather is nice enough, outside would be ideal.
2. Fill your water gun with water. Pump it a couple of times and shoot it, then top it off. So the water gun works properly, leave a small amount of air in the tank.
3. Mount your water gun on a sturdy surface approximately a meter above the ground. The gun should be mounted on its side and secured with duct tape. Once secured, make sure you can still squeeze the trigger and move the pump.
4. Measure the height of the nozzle above the ground.
5. Make sure to have a tape measure on hand to measure the distance later.
6. Designate one group member to be responsible for marking where the water lands.

FIRE!

1. Pump the water gun the number of times you have decided for your first trial, and shoot the water. Hold the trigger until the water has stopped coming out, to ensure that no pressure is left in the chamber.
2. Measure the distance between the nozzle and where the water lands.
3. Repeat this procedure for each trial.

Data Table

Draw your data table in the space below, and record your data and measurements in the table.

Number of Pumps	Maximum Distance (ft)
1	
2	
3	
4	
5	
6	
7	
8	
9	
10	

Calculations

Using the data you collected and the equations given in the Background and Theory section, solve for the pressure inside the water gun at each pump. To save time, try doing these calculations in an Excel spreadsheet. If you do the calculations by hand, show your work on a separate sheet of paper.

Graphing

On a separate sheet of graph paper, or in Excel, graph the pressure vs. the number of pumps. Also graph the distance the water travelled vs. the number of pumps. What does the graph tell you about the relationship between water pressure and the number of pumps?

Answers could vary, depending on the type of water gun and its valve mechanisms.

Solar Cooker

Objective: Students will be able to build a solar oven that uses conduction to convert sunlight into energy.

Time Frame: 60-80 minutes

Team Members: 2-4

Materials:

- Oven Thermometer (one at minimum. One per group is ideal)
- Pizza Box Solar Oven instructions handout
- Pizza Box (either recycled or acquired from a pizza store) – 1 per group
- Newspaper (have students collect or bring from home)
- black construction paper – 5 per group
- Aluminum Foil – 6 feet per group
- Transparency sheets – 2 per group
- Scotch Tape – 1 per group
- Non-toxic glue – 1 per group
- straws – 2 per group
- Graham Crackers – 2 per student
- Milk Chocolate Bar – 1 per group
- Large Marshmallows – 1 per student
- Scissors
- Markers
- Rulers

Procedure:

Resources: <http://www.solarcookers.org/> A group that helps 3rd world countries build and maintain solar cookers.

<http://energy.gov/eere/education/education-homepage> The governments website with good solar resources

Intro: Tell the students that they will be building a simple solar oven today. Ask students if they know how solar ovens work. Make sure that the concept of conduction (the transfer of heat energy from one medium to another) is discussed. Hand out the Pizza Box Solar Oven handout.

Activity: Have the students build their ovens. It should take no longer than 30 minutes. When they are done, they may take their graham crackers and marshmallows and make S'mores.

Closure: Ask students to brainstorm for more efficient designs. If they were going to make one on their own, how would they modify the design? Enjoy the S'mores



This solar oven has been adapted from many designs. If you make one on your own please feel free to improvise! For today please follow the directions below.

The pizza box solar oven can reach temperatures of 275 degrees, hot enough to cook food and to kill germs in water. A general rule for cooking in a solar oven is to get the food in early and don't worry about overcooking. Solar cookers can be used for six months of the year in northern climates and year-round in tropical locations. Expect the cooking time to take about twice as long as conventional methods, and allow about one half hour to preheat. At home you can try cooking hot dogs or English muffin pizzas, you can even try to bake cookies or biscuits.

What You'll Need

- Recycled pizza box
- Black construction paper
- Aluminum foil
- Transparency Sheets (Another clear plastic will also work) or Saran-Wrap
- Non-toxic glue, tape, scissors, ruler, magic marker
- Wooden dowel or straw

How to Make Your Pizza Box Oven

1. Make sure the cardboard is folded into its box shape.
2. Draw a 7.5" by 10" rectangle on the top of the box. Cut along three sides leaving the line along the back of the box uncut. (Diagram #1)
3. Form a flap by gently folding back along the uncut line to form a crease. (Diagram #2)
4. Cut a piece of aluminum foil slightly larger than the flap. Wrap the underside (inside) face of this flap with the aluminum foil. Tape it so that the foil is held firmly but so that there's not too much tape showing on the foil side of the flap. (Diagram #2)
5. Tape the transparency sheet to the underside of the lid opening to cover the hole. If possible add another transparency to the top of the lid opening. Be sure the plastic creates a tightly sealed window so that the air cannot escape from the oven interior. (Diagram#2)

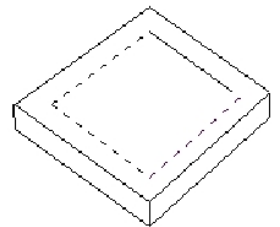

Diagram #1

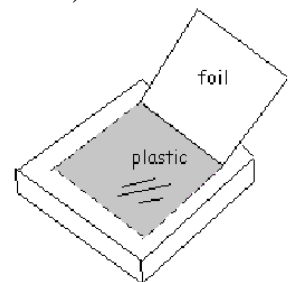

Diagram #2

6. Cut another piece of foil to line the bottom of the pizza box and carefully glue into place. Cover the foil with a piece of black construction paper and tape into place. (Diagram #3)

7. Roll up some newspaper and fit it around the inside edges of the box to act as insulation. It should be about 1-1.5" thick. Use tape or other materials you can think of to hold the newspaper in place.

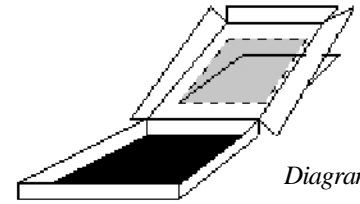
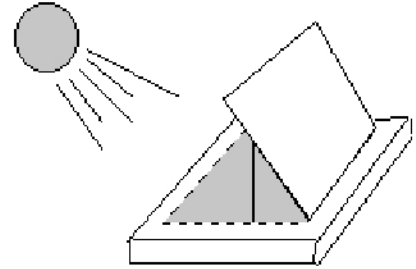

Diagram #3

8. Close the pizza box top (window), and prop open the flap of the box with a straw and face towards the sun. (Diagram #4) Adjust until the aluminum reflects the maximum sunlight through the window into the oven interior.

9. Your oven is ready! Take your graham crackers, chocolate and marshmallow and have a s'more.

10. If available, test how hot your oven can get using a simple oven thermometer!



Survival Still

Grades: 9-12

Topic: Solar

Owner: Florida Solar Energy Center

Survival Still

Student Objective:

The student:

- will be able to explain a simple way to desalinate water using solar energy
- will be able to explain capillary water in the soil and be able to explain how to construct a solar still to extract water from the soil.

Materials:

- sheet of thick, transparent flexible plastic at least 1 m square (1 per group)
- coffee can (1 per group)
- shovel (1 per group)
- rocks
- graduated cylinder

Key Words:

capillary water
condensation
conduction
convection
desalinization
evaporation
radiation
solar still
thermal energy

Time:

1 class period plus 20 minutes

Background Information:

Stills are commonly used to purify liquids. Through the process of distillation, non-volatile impurities can be separated from the liquid. Distillation can be a simple process. Heat is first added to a liquid to evaporate it and produce a gas or vapor, then heat is removed from the vapor to condense it back to a liquid.

Soil always contains some moisture, but it is often in the form of capillary water. Capillarity is the force that exists between soil particles and water molecules. This force prevents all the water in the soil from draining down through the soil. The water that remains as a thin coating around the soil particles is known as capillary water.

A solar still allows this capillary water to be recovered and purified in the process. By creating a closed space with a transparent cover material, a greenhouse effect is produced which causes the temperature inside the space to rise. The trapped heat is absorbed by the soil and causes its moisture to vaporize. This vapor rises and condenses on the inside of the plastic where it then runs down and drips into the container of the still.

Procedure (prior to class):

1. Scout out your school for an area where you can build the solar still. The area must be in full sun, and you will need to be able to dig a hole (about 80 cm in diameter) there.

2. If you have a large class you may want to divide them up into two or three working groups, and let each group build their own still. Of course you will need to have materials available for each group and a place for them to dig their still.
3. Make sure there are a few fist sized rocks at each location for the groups to ‘find’.

Procedure (during class):

1. Lead the class in a discussion of desalination and their results from the Solar Still investigation. Ask the class what capillary water is, and give them the definition and explanation if they are unsure of it.
2. Explain to the class that they will be using what they learned in the Solar Still investigation to design and construct a solar still that will remove the moisture from the soil and produce purified drinking water.
3. Tell the students that as of now they are stranded on a deserted island with no fresh water. They have to make a solar still to obtain drinking water to survive.
4. Show the students their materials that they ‘found’ on the island (a sheet of plastic, a coffee can and a shovel)--take them out to the approved area to build their stills, and wish them luck.
5. During the construction process, encourage them to brainstorm among themselves to figure out the solution. Try not to directly help them if at all possible.
6. Leave the solar stills overnight and check them during the next class period. Have the students measure the amount of water collected in the container. If no water has condensed, have the students figure out why, change their design, and check it during the next class period. Note: Common problems are not enough of a slope into the collecting container (it needs to be at least 35°), too much air (and moisture) escaping around the edges of the plastic, or the weight is not right over the center of the collecting container.
7. After they have successfully built the solar still, have them complete their Science Journal.

Related Research:

1. How does the size and shape of an in-ground still affect the rate of water collection? Vary the depth and/or the width of the still and tabulate the results.
2. Would having living plants in your solar still system increase the amount of water collected? Compare the rate of water collection from equal areas of bare soil and soil covered with plants.
3. In many areas of the world, pure water is becoming very scarce. Research national and international plans and projects for obtaining pure water.
4. How much water is required for survival? How would you design a still that will provide enough water for yourself and a family of four?

Related Reading

- *A Golden Thread: 2500 Years of Solar Architecture and Technology* by Ken Butti & John Perlin (Cheshire Books, 1980)

A Golden Thread provides a historical perspective of the influence of solar energy on society throughout the ages. The book provides information relating to the scientific, societal and economic influences contributing to the development of solar technology, as well as explanations of how the various forms of solar technology function.

- ***How to Build a Solar Hot Water System*** by John Canivan (Sunny Future Press, 2002)
Step by step procedures and explanations for building a simple solar hot water system.
- ***The Return of the Solar Cat*** by Jim Augustyn (Patty Paw Press, 2003)
"A cat sunning itself in the doorway of a barn knows all about solar energy. Why can't man learn?" (E.B.White). The Return of the Solar Cat book decisively answers this question. Jim Augustyne takes the Suessian approach to showing the reader our myopia when it comes to the nature of renewable energy, politics, and economics through the fun-house mirror of technologically advanced felines and their 'natural' instincts and behavior which are optimized for solar utilization. Augustyne has developed an alternate universe of whimsy and pointy satire where kitties rule and our human foibles and blindness to the advantages of solar energy are entertainingly exposed

Internet Sites

<http://www.desertusa.com/mag98/dec/stories/water.html>

Desert USA's page detailing how to make a survival still in the desert.

http://www.ehow.com/how_12584_make-solar-still.html

How Things Get Done - How to make a solar still in the wilderness.

EnergyWhiz

Be an EnergyWhiz star! Submit pictures of your class' in ground solar still with a description of its size and building materials to **<http://energywhiz.com/>**. See your class on the internet!

Survival Still

Benchmark SC.A.1.4.3 - The student knows that a change from one phase of matter to another involves a gain or loss of energy.

Benchmark SC.B.1.4.1 - The student understands how knowledge of energy is fundamental to all the scientific disciplines.

Benchmark SC.B.1.4.2 - The student understands that there is conservation of mass and energy when matter is transformed.

Benchmark SC.B.1.4.3 - The student knows that temperature is a measure of the average translational kinetic energy of motion of the molecules in an object.

Benchmark SC.B.1.4.5 - The student knows that each source of energy presents advantages and disadvantages to its use in society.

Benchmark SC.D.1.4.1 - The student knows how climatic patterns on Earth result from an interplay of many factors.

Survival Still

capillary water - the thin film of water that coats the soil particles even in the driest soil

condensation - a reduction to a denser form as from steam to water

conduction - the movement of heat or cold through materials that are solid

convection - the movement of heat or cold through air or liquids

desalinization - process of removing salt and other chemicals and minerals from water

evaporation - process of changing a liquid into vapor

radiation - the way we receive heat from the sun each day. The energy is emitted in the form of waves/particles, and can move from one object to another without heating the area in between.

solar still - a device that uses solar energy to evaporate a liquid

thermal energy - energy that heats something

Survival Still

1. At what rate was the water removed from the soil and collected in the container?
2. What design problems did you encounter and what did you do to correct them?
3. Would you be able to collect capillary water in the desert? Why or why not?

Straw Rockets

OBJECTIVE: To allow students to visualize the relationship between the elastic potential energy of a rubber band and gravitational potential energy.

DESCRIPTION: In this activity, students construct a rubber band rocket launcher and a graduated straw rocket. They launch rockets and calculate the Gravitational Potential Energy.

MATERIALS: 3 straws per group
Masking tape
Scissors
Sharpie or pen that will mark on straws
Toilet paper tube
Rubber band

PROCEDURE:

1. Construct Launcher: Cut a rubber band and tape it across the open end of the cardboard tube. The rubber band should be taut, but only stretched a small amount.
2. Construct Rocket: Cut about 3cm off of a straw. Lay two full-length straws side by side on a flat surface with the 3cm piece between them. Arrange so that one set of ends are even. Tape the straws together side by side. Starting from the untaped end, make marks every centimeter on one of the long straws and on the other write the measurement.
3. Create a data table that has five different amounts of stretch, three trials for each amount, average, and a final column for the calculated Gravitational Potential Energy. See example below.

Amount of Stretch (cm)	Height (Trial 1) (m)	Height (Trial 2) (m)	Height (Trial 3) (m)	Average Height (m)	Gravitational Potential Energy (mJ)

4. Launch the rocket straight up and measure the height in meters using a meter stick, an altimeter, or any means that are available. For each amount of stretch, find the average height the rocket travels.
5. Measure the mass of the rocket in grams.
6. Calculate the gravitational Potential energy by using the following formula: $GPE = \text{Mass of rocket} \times \text{Gravitational acceleration } (9.8\text{m/s}^2) \times \text{Height}$. The unit of energy is the millijoule (mJ). Record results in your data table.
7. Graph your results. Show GPE on the vertical axis and the stretch on the horizontal axis.

DISCUSSION:

Look at the shape of the graph. What does this tell you about the relationship between GPE and the elastic potential energy of the rubber band? How does the energy of the rocket before it was released relate to the amount after? Where did this energy go? What other variables may have affected the height of the rocket.

EXTENSION:

Change the variable from stretch to angle or change the mass of the rocket using paper clips. See if students can create other variables they can manipulate.

Technical Pictionary

Objective: Students will be able to identify a technical term from picture clues drawn by team members

Team Members: 2-4

Total Approximate Time: 60 minutes

Materials Needed:

- Whiteboard or SMART board
- Markers
- Technical Terms
- Index cards
- Timer

Rules:

1. Team will choose someone to draw. Rotate through team members as the rounds progress. Once you have drawn, you may not draw again until all other members of your team have drawn
2. Select a word. Do not show it to anyone else
3. You will have 1 minute (60 seconds) to draw your word.

Sketching Rules:

- **No letters, words or numbers can be drawn. Symbols such as dollar signs(\$), arrows(t), plus signs(+), etc. are acceptable. However, if part of a name or phrase is guessed correctly, you may write that word next to your sketch – just like on TV!**
 - **Never speak while sketching – but you may gesture to indicate whether the guess is close or off-track!**
 - **You may also draw an ear to mean “sounds like” and then sketch a rhyming word.**
4. After 1 minute, if the team has not given the correct answer, opposing teams will have 10 seconds to guess.
 5. The first team to 8 points wins.

Procedures:

Prep: Prepare a set of index cards of technical terms. Choose terms that relate to whatever your MESA group has discussed or terms from Math and Science. Some places to find terms:

Engineering Terms: <http://www.engineering-dictionary.org/>

Math Terms: http://www.mathwords.com/a_to_z.htm

Science Terms: <http://sci2.esa.int/glossary/>

Intro: Tell students that one of the important parts of engineering is being able to draw and understand the drawings of other people. Technical drawings are an important part of engineering as they help others understand what you are designing/building. So, today you are going to play a game using technical terms to understand the important of good drawings. Divide the students into groups. Explain the rules of “Win, Lose, or Draw.”

Activity: Have students decide who will be the artist. Have them come up, choose a card, and prepare to draw. Tell the student to begin and start the timer. Monitor the groups to make sure that only the artist’s team is guessing and if they choose the correct word. Synonyms are not allowed but forms of the word are (electricity for electrical, sun for solar, etc.).

Closure: Talk about the struggles the students went through. Did they understand the drawings? Did they know the proper terms? Make a point to tell them that a good drawing makes designing and understanding the design so much easier than trying to guess.



TINKER TOY TOWER

OBJECTIVE: To build the tallest most cost effective tower free-standing structure. In other words, build the tallest structure with the least possible cost per centimeter.

COST OF MATERIALS PER ITEM:	\$10	Red wheel	\$6	Green Rod
	\$9	Purple Rod	\$4	Purple connector
	\$8	Blue Rod	\$5	Green bearing
	\$8	Blue spinning spool	\$3	Orange washer
	\$7	Red rod	\$3	Red triangle
	\$7	Yellow connector spool	\$2	Orange end cap

DESIGN PARAMETERS:

- Only the materials listed may be used.
- Design may or may not encompass all materials in the container.
- Design must be free-standing at time of measurement.

EXPENSE REPORT

Item	Unit Cost	x	Quantity	=	Cost
1.					
2.					
3.					
4.					
5.					
6.					
7.					
8.					
9.					
10.					
11.					
12.					
TOTAL COST (\$)					
HEIGHT OF STRUCTURE (cm)					
COST EFFECTIVENESS (\$/cm)					

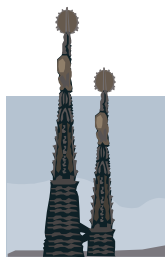

Kit List

Red triangle	1
Red wheel	2
Blue spinning spool	2
Orange end cap	2
Orange washer	2
Purple rod	2
Green rod	4
Red rod	4
Blue rod	4
Green bearing	4
Purple connector	4
Yellow connector spool	4



Week	1
Sequence of Activities	<ul style="list-style-type: none"> • Name Game • Solar Oven Construction • Introduction to MESA • Solar Oven Discussion
Duration	60-80 minutes
Age Level	High School
Essential Question	How does the solar oven convert light to heat?
Learning Objectives	<p>Pizza Box Solar Oven</p> <ul style="list-style-type: none"> • TSW will learn how sunlight is converted to heat (conduction) • TSW will recognize the energy is conserved in a closed system • TSW will recognize that black objects absorb sunlight • TSW will use the law of reflection to capture sunlight <p>Introduction to MESA</p> <ul style="list-style-type: none"> • TSW will learn about the purpose and objectives of MESA
Other Objectives	<ul style="list-style-type: none"> • TSW will meet and learn the names of the other MESA students • TSW will practice teamwork • TSW will practice non-verbal communication
Key Terms	<ul style="list-style-type: none"> • Energy Transfer • Energy Conservation • Conduction • Insulation • Insolation
Materials Needed	<p>Pizza Box Solar Oven</p> <p>Per Group</p> <ul style="list-style-type: none"> • Oven Thermometer (optional) <p>Per Student</p> <ul style="list-style-type: none"> • MESA Diary Handout • Pizza Box Solar Oven instructions handout <p>Per Team (2-3 students)</p> <ul style="list-style-type: none"> • Pizza Box (either recycled or acquired from a pizza store) • Newspaper (have students collect or bring from home) • 5 sheets black construction paper • 6 feet of Aluminum Foil • 2 Transparency sheets • Scotch Tape • Non-toxic glue • 2 straws • Graham Crackers - 2 per student • Milk Chocolate Bar - 1 per group • Large Marshmallows - 1 per student <p>Equipment Needed:</p> <ul style="list-style-type: none"> • Scissors or Box cutters • Ruler • Markers
Lead In	<ol style="list-style-type: none"> 1. Ask students to sign in on attendance sheet. 2. Welcome them to MESA <p>Memory Game</p> <ol style="list-style-type: none"> 3. Ask the students to introduce themselves loud and clear giving their name and why they are here. Also, tell everyone that it is important that they listen to everyone.

	<ol style="list-style-type: none"> 4. Make sure everyone's introduction is loud and clear. 5. After everyone has introduced themselves tell everyone to stand. Let them know that they will have 3 minutes to put themselves into alphabetical order, but there are Rules: 1) can only use helpful pointing, 2) no talking, no signing, no gesturing 6. After three minutes, have everyone repeat their name to see how close they were. 7. Tell the students to sit and then ask them "It is hot enough to fry an egg outside?" 8. Wait for their response and then ask "Do you want to prove it?" 9. Explain that although they won't be actually frying eggs, then will be cooking using only the sun today. 10. Ask student to divide themselves into groups of 2-3 or place them in groups if necessary. 11. Explain that each group will be building a Solar Oven and that if all goes well they will leave with a little treat.
Activity	<p>Pizza Box Solar Oven</p> <ol style="list-style-type: none"> 1. Handout the Pizza Box Solar Oven directions to each student 2. Handout the materials to each group. 3. Ask the students to follow the directions to create their ovens. 4. After student have completed their ovens 5. Have the group go outside and position their ovens and starting baking their S'mores, and then return to classroom. 6. Handout MESA Diary 7. Ask student's to draw a diagram of their oven on their Diary. Then ask them to label the different parts of the oven (i.e. reflective flap, window, insulation, interior) 8. Ask student what they think is happening in their solar ovens. Make sure they discuss the role of each part. Lead the discussion so that students understand and can define that their oven is a closed system that transfers energy trough conduction and conserves it through insulation. 9. Have the students draw or describe the process under procedure. 10. Have students define energy transfer, conduction, and energy conservation in their MESA Diary. 11. Ask the students to retrieve their ovens and return to the classroom. 12. Have them examine each others results and then sit and enjoy 13. After they sit down to enjoy their S'mores, move on to the Intro of MESA
Closure	<p>Introduction to MESA</p> <ol style="list-style-type: none"> 1. Ask students why they are interested in MESA. 2. Ask students what they think MESA is about and what they think they will be doing at MESA meetings. 3. Introduce and discuss what MESA is about and how it will make them more successful in various aspects of their life. 4. Have a former member of MESA describe their experiences with MESA and allow students the opportunity to ask questions. 5. Thank the students for attending and ask the students to answer the following question in the conclusion portion of their Diary. "What factors played a key role in the success/failure of their pizza box oven?" 6. Inform students of the next MESA meeting and give them a heads up that the next activity is called "Index Card Tower".
Informal Assessment	<ul style="list-style-type: none"> • Monitor students to check for understanding of directions. • Monitor the students to check for participation.
Formal Assessment	<ul style="list-style-type: none"> • Student's should have created an oven that melted the chocolate and marshmallows.
Trouble Shooting	<ul style="list-style-type: none"> • Have materials prep-packaged inside a pizza box to hand them out faster. • Have a demo oven that you created to help students. • Keep an eye on time.

	<ul style="list-style-type: none"> If short on time, ask students to research conduction for the following meeting to ensure you have time to do Introduction to MESA. 						
Extension	<ul style="list-style-type: none"> Have students use an oven thermometer to track the temperature of their ovens at different times of the day, different intervals of time, different times of the year and then analyze their observations You can use the following websites to delve deeper into solar cooking <ul style="list-style-type: none"> http://www1.eere.energy.gov/education/learning.html http://www.solarcooking.org/default.htm Discussion about best use of solar cooking. (i.e. reduce energy consumption, third world applications) Discussion about ways to improve their ovens Discussion about other application of solar energy 						
SEI Strategies Used							
<table border="0"> <tr> <td style="vertical-align: top;"> Preparation <input type="checkbox"/> Adaptation of Content <input type="checkbox"/> Links to Background <input type="checkbox"/> Links to Past Learning <input type="checkbox"/> Strategies incorporated </td> <td style="vertical-align: top;"> Scaffolding <input type="checkbox"/> Modeling <input checked="" type="checkbox"/> Guided practice <input type="checkbox"/> Independent practice <input type="checkbox"/> Comprehensible input </td> <td style="vertical-align: top;"> Grouping Options <input checked="" type="checkbox"/> Whole class <input checked="" type="checkbox"/> Small groups <input type="checkbox"/> Partners <input type="checkbox"/> Independent </td> </tr> <tr> <td style="vertical-align: top;"> Integration of Processes <input checked="" type="checkbox"/> Reading <input checked="" type="checkbox"/> Writing <input checked="" type="checkbox"/> Speaking <input checked="" type="checkbox"/> Listening </td> <td style="vertical-align: top;"> Application <input checked="" type="checkbox"/> Hands-on <input checked="" type="checkbox"/> Meaningful <input type="checkbox"/> Linked to objectives <input checked="" type="checkbox"/> Promotes engagement </td> <td style="vertical-align: top;"> Assessment <input checked="" type="checkbox"/> Individual <input checked="" type="checkbox"/> Group <input checked="" type="checkbox"/> Written <input checked="" type="checkbox"/> Oral </td> </tr> </table>		Preparation <input type="checkbox"/> Adaptation of Content <input type="checkbox"/> Links to Background <input type="checkbox"/> Links to Past Learning <input type="checkbox"/> Strategies incorporated	Scaffolding <input type="checkbox"/> Modeling <input checked="" type="checkbox"/> Guided practice <input type="checkbox"/> Independent practice <input type="checkbox"/> Comprehensible input	Grouping Options <input checked="" type="checkbox"/> Whole class <input checked="" type="checkbox"/> Small groups <input type="checkbox"/> Partners <input type="checkbox"/> Independent	Integration of Processes <input checked="" type="checkbox"/> Reading <input checked="" type="checkbox"/> Writing <input checked="" type="checkbox"/> Speaking <input checked="" type="checkbox"/> Listening	Application <input checked="" type="checkbox"/> Hands-on <input checked="" type="checkbox"/> Meaningful <input type="checkbox"/> Linked to objectives <input checked="" type="checkbox"/> Promotes engagement	Assessment <input checked="" type="checkbox"/> Individual <input checked="" type="checkbox"/> Group <input checked="" type="checkbox"/> Written <input checked="" type="checkbox"/> Oral
Preparation <input type="checkbox"/> Adaptation of Content <input type="checkbox"/> Links to Background <input type="checkbox"/> Links to Past Learning <input type="checkbox"/> Strategies incorporated	Scaffolding <input type="checkbox"/> Modeling <input checked="" type="checkbox"/> Guided practice <input type="checkbox"/> Independent practice <input type="checkbox"/> Comprehensible input	Grouping Options <input checked="" type="checkbox"/> Whole class <input checked="" type="checkbox"/> Small groups <input type="checkbox"/> Partners <input type="checkbox"/> Independent					
Integration of Processes <input checked="" type="checkbox"/> Reading <input checked="" type="checkbox"/> Writing <input checked="" type="checkbox"/> Speaking <input checked="" type="checkbox"/> Listening	Application <input checked="" type="checkbox"/> Hands-on <input checked="" type="checkbox"/> Meaningful <input type="checkbox"/> Linked to objectives <input checked="" type="checkbox"/> Promotes engagement	Assessment <input checked="" type="checkbox"/> Individual <input checked="" type="checkbox"/> Group <input checked="" type="checkbox"/> Written <input checked="" type="checkbox"/> Oral					
Arizona Math Standards Addressed	<ul style="list-style-type: none"> None 						
Arizona Science Standards Addressed	<ul style="list-style-type: none"> S5C3: TSW understand ways that energy is conserved, stored, or transferred by describing various ways energy is transferred from one system to another. 						

Pizza Box Solar Oven

This solar oven has been adapted from many designs. If you make one on your own please feel free to improvise! For today please follow the directions below.

The pizza box solar oven can reach temperatures of 275 degrees, hot enough to cook food and to kill germs in water. A general rule for cooking in a solar oven is to get the food in early and don't worry about overcooking. Solar cookers can be used for six months of the year in northern climates and year-round in tropical locations. Expect the cooking time to take about twice as long as conventional methods, and allow about one half hour to preheat. At home you can try cooking hot dogs or English muffin pizzas, you can even try to bake cookies or biscuits.

What You'll Need

- Recycled pizza box
- Black construction paper
- Aluminum foil
- Transparency Sheets (Another clear plastic will also work) or Saran-Wrap
- Non-toxic glue, tape, scissors, ruler, magic marker
- Wooden dowel or straw

How to Make Your Pizza Box Oven

1. Make sure the cardboard is folded into its box shape.
2. Draw a 7.5" by 10" rectangle on the top of the box. Cut along three sides leaving the line along the back of the box uncut. (Diagram #1)

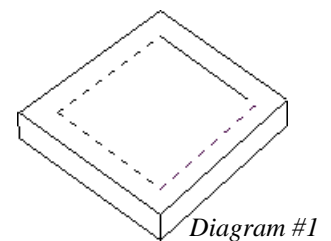

3. Form a flap by gently folding back along the uncut line to form a crease. (Diagram #2)
4. Cut a piece of aluminum foil slightly larger than the flap. Wrap the underside (inside) face of this flap with the aluminum foil. Tape it so that the foil is held firmly but so that there's not too much tape showing on the foil side of the flap. (Diagram #2)

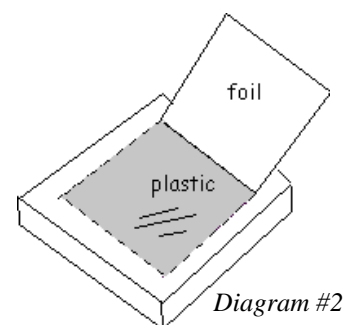

5. Tape the transparency sheet to the underside of the lid opening to cover the hole. If possible add another transparency to the top of the lid opening. Be sure the plastic creates a tightly sealed window so that the air cannot escape from the oven interior. (Diagram#2)
- 6.

6. Cut another piece of foil to line the bottom of the pizza box and carefully glue into place. Cover the foil with a piece of black construction paper and tape into place. (Diagram #3)

7. Roll up some newspaper and fit it around the inside edges of the box to act as insulation. It should be about 1-1.5" thick. Use tape or other materials you can think of to hold the newspaper in place.

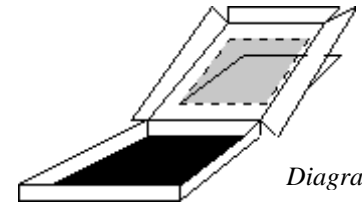

Diagram #3

8. Close the pizza box top (window), and prop open the flap of the box with a straw and face towards the sun. (Diagram #4) Adjust until the aluminum reflects the maximum sunlight through the window into the oven interior.

9. Your oven is ready! Take your graham crackers, chocolate and marshmallow and have a s'more.

10. If available, test how hot your oven can get using a simple oven thermometer!

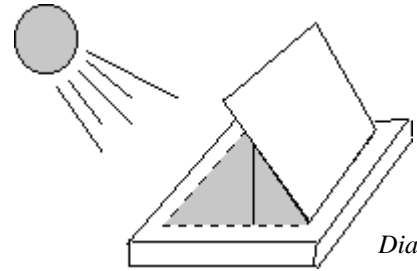

Diagram #4

Week	2
Sequence of Activities	<ul style="list-style-type: none"> • Math Puzzle: Mystery Math Ball! A Logic-based Mystery (15-20 minutes) • MESA Activity: Index Card Tower (30-35 minutes) • MESA Calendar (15-20 minutes)
Duration	60-80 minutes
Age Level	High School
Essential Question	How does the manipulation of index card shape and size engineer a stronger tower?
Learning Objectives	<p>Math Puzzle</p> <ul style="list-style-type: none"> • TSW solve higher order math logic puzzles using grade level problem solving strategies • TSW use reasoning to solve mathematical logic puzzles using given information <p>Index Card Tower</p> <ul style="list-style-type: none"> • TSW design and construct a tower made of index cards • TSW manipulate individual index cards to various shapes and sizes with folds and cuts to maximize the strength and efficiency of their tower. • TSW compare their index card tower to those of their peers and analyze the strengths and weaknesses of each
Other Objectives	<ul style="list-style-type: none"> • TSW develop a working plan with their group to develop a cooperative environment • TSW communicate with their group by contributing their vocal input
Key Terms	<ul style="list-style-type: none"> • None
Materials Needed	<p>Math Puzzle</p> <ul style="list-style-type: none"> • Handout: The Mystery Math Ball! A Logic-based Mystery <p>Index Card Tower</p> <p>Per Group</p> <ul style="list-style-type: none"> • Stopwatch • Measuring Tape • Sturdy wooden or plastic clipboard • Textbooks • Scale <p>Per Student</p> <ul style="list-style-type: none"> • Handout: MESA Notebook <p>Per Team of 2-3 Students</p> <ul style="list-style-type: none"> • Handout: Index Card Tower Design Competition • 100 Index Cards <p>MESA Calendar</p> <ul style="list-style-type: none"> • MESA Calendar Handouts or Overhead
Lead In	<p>Math Puzzles</p> <ol style="list-style-type: none"> 1. Pass puzzles out to students as they arrive for MESA meeting. Remind them to sign in on attendance sheet. 2. Inform students that they may work in groups of 2. Instruct them not to give the answer if they solve it before time is up. 3. Monitor and guide students to the solution. 4. After 20-25 minutes, discuss each puzzle, its solution, and the logic reasoning student used to solve it. Call on students at random or have them volunteer to explain their problem solving strategies.
Activity	<p>Index Card Tower</p> <ol style="list-style-type: none"> 1. Pass out the MESA Notebook handout. Tell them that they will be completing this handout for each MESA activity. Tell them you will guide them through the handout today. 2. Pass out Handout: Index Card Tower Design 3. Read handout with students and have them re-tell you the activity in their own words. Check for understanding and ask if they have any questions.

	<ol style="list-style-type: none"> 4. Show the students the clipboard that will be used to test their towers so they have a general understanding of how it will be tested. Tell them that textbooks will be placed on top of the clipboard. 5. Tell students they have 20 minutes to construct their tower using only the index cards. 6. Begin time using stopwatch and monitor student progress. Check to make sure they are only using the index cards. Ask questions to guide them toward manipulation of cards using tears and folds. 7. After 20 minutes, call time. 8. Have each team look at the towers of other teams. As a group, hypothesize about which tower they think will be the strongest. Discuss predictions and make inferences to structural design and engineering. 9. Put the clipboard on top of each tower. Begin stacking books until the tower collapses. 10. Find the weight of the clipboard and the textbooks. Use the simple scoring formula at the bottom of the handout to find out which team has the best design. 11. Clean up. 12. Tell students to take out their MESA Notebook handout. 13. Review the basic sections of the handout to familiarize students with layout. 14. Ask students, "What was the purpose of the activity today? What were we trying to accomplish?" Solicit answers. Tell them that each activity should have a purpose. Generate a general purpose on the board that the students agree on. <i>Ex. The purpose of this activity is to construct a tower out of index cards.</i> Tell students to write this in the 'purpose' section of their notebook. 15. Now, tell students to fill in the materials used section. "What materials did you use to complete this activity?" Have students complete 'materials used' section. 16. Point to the 'procedure' section and explain that this is where a chunk of their diary is. The procedure section is a step by step reflection of what the student did to accomplish the activity. It should be in sequential order and written toward a general audience. Tell students to be as thorough as possible. <i>For example, "My team got the index cards. We discussed how we were going to make the base of the tower. We began the base using 10 index cards. We added a second layer using 8 cards. Etc..."</i> 17. The last section is the 'conclusion' section. Tell students that the advisor will be writing a conclusion question for each activity. They will answer this question in the 'conclusion' section. Write the following question on the board, "How does the manipulation of index card shape and size engineer a stronger tower?" Tell them to use what they learned from the activity to answer this question." <p><i>*Note: Students may complete the 'Procedure' and 'Conclusion' section of the MESA Notebook at home before the next MESA meeting if time is an issue.</i></p>
Closure	<p>MESA Calendar</p> <ol style="list-style-type: none"> 1. Pass out a MESA calendar for the year or show them on an overhead. 2. Point out all the dates that involve students and give them a brief explanation of what will happen at each event. 3. When discussion Southern Regionals and MESA Day, emphasize that students will be engineering and constructing projects just like the geodesic dome in competition. 4. Ask for questions and discuss.
Informal Assessment	<ul style="list-style-type: none"> • Monitor students to check for understanding • Monitor students to check for participation
Formal Assessment	<ul style="list-style-type: none"> • Completed Index Card Tower • Completed MESA Notebook (They may complete this before the next MESA meeting)

Extensions	<ul style="list-style-type: none"> • Use activity to demonstrate Newton’s 3rd law to explain the interactions of forces between bodies. 						
Trouble Shooting	<ul style="list-style-type: none"> • Make sure students understand the rules for this activity • Reset scale after each weighing of plywood and textbooks • Make sure all students participate in clean up 						
SEI Strategies Used <table border="0" style="width: 100%;"> <tr> <td style="vertical-align: top; width: 33%;"> Preparation <input type="checkbox"/> Adaptation of Content <input type="checkbox"/> Links to Background <input type="checkbox"/> Links to Past Learning <input checked="" type="checkbox"/> Strategies incorporated </td> <td style="vertical-align: top; width: 33%;"> Scaffolding <input type="checkbox"/> Modeling <input type="checkbox"/> Guided practice <input type="checkbox"/> Independent practice <input type="checkbox"/> Comprehensible input </td> <td style="vertical-align: top; width: 33%;"> Grouping Options <input type="checkbox"/> Whole class <input checked="" type="checkbox"/> Small groups <input type="checkbox"/> Partners <input type="checkbox"/> Independent </td> </tr> <tr> <td style="vertical-align: top;"> Integration of Processes <input checked="" type="checkbox"/> Reading <input checked="" type="checkbox"/> Writing <input checked="" type="checkbox"/> Speaking <input checked="" type="checkbox"/> Listening </td> <td style="vertical-align: top;"> Application <input checked="" type="checkbox"/> Hands-on <input checked="" type="checkbox"/> Meaningful <input checked="" type="checkbox"/> Linked to objectives <input checked="" type="checkbox"/> Promotes engagement </td> <td style="vertical-align: top;"> Assessment <input checked="" type="checkbox"/> Individual <input type="checkbox"/> Group <input type="checkbox"/> Written <input type="checkbox"/> Oral </td> </tr> </table>		Preparation <input type="checkbox"/> Adaptation of Content <input type="checkbox"/> Links to Background <input type="checkbox"/> Links to Past Learning <input checked="" type="checkbox"/> Strategies incorporated	Scaffolding <input type="checkbox"/> Modeling <input type="checkbox"/> Guided practice <input type="checkbox"/> Independent practice <input type="checkbox"/> Comprehensible input	Grouping Options <input type="checkbox"/> Whole class <input checked="" type="checkbox"/> Small groups <input type="checkbox"/> Partners <input type="checkbox"/> Independent	Integration of Processes <input checked="" type="checkbox"/> Reading <input checked="" type="checkbox"/> Writing <input checked="" type="checkbox"/> Speaking <input checked="" type="checkbox"/> Listening	Application <input checked="" type="checkbox"/> Hands-on <input checked="" type="checkbox"/> Meaningful <input checked="" type="checkbox"/> Linked to objectives <input checked="" type="checkbox"/> Promotes engagement	Assessment <input checked="" type="checkbox"/> Individual <input type="checkbox"/> Group <input type="checkbox"/> Written <input type="checkbox"/> Oral
Preparation <input type="checkbox"/> Adaptation of Content <input type="checkbox"/> Links to Background <input type="checkbox"/> Links to Past Learning <input checked="" type="checkbox"/> Strategies incorporated	Scaffolding <input type="checkbox"/> Modeling <input type="checkbox"/> Guided practice <input type="checkbox"/> Independent practice <input type="checkbox"/> Comprehensible input	Grouping Options <input type="checkbox"/> Whole class <input checked="" type="checkbox"/> Small groups <input type="checkbox"/> Partners <input type="checkbox"/> Independent					
Integration of Processes <input checked="" type="checkbox"/> Reading <input checked="" type="checkbox"/> Writing <input checked="" type="checkbox"/> Speaking <input checked="" type="checkbox"/> Listening	Application <input checked="" type="checkbox"/> Hands-on <input checked="" type="checkbox"/> Meaningful <input checked="" type="checkbox"/> Linked to objectives <input checked="" type="checkbox"/> Promotes engagement	Assessment <input checked="" type="checkbox"/> Individual <input type="checkbox"/> Group <input type="checkbox"/> Written <input type="checkbox"/> Oral					
Arizona Math Standards Addressed	<ul style="list-style-type: none"> • S5C1: TSW use reasoning to solve mathematical problems in contextual situations. 						
Arizona Science Standards Addressed	<ul style="list-style-type: none"> • S2C2: TSW design and conduct a controlled investigation and record observations, notes, sketches, and ideas using tools such as a journal. • S1C4: TSW communicate the results of an investigation. 						

Team Members:-

Index Card Tower Design Competition

Goal:

Your team will build a tower that carries the greatest amount of weight using the least amount of index cards.

You will work in teams of 2-3 students and must build a tower that is at least 11 inches tall. Your team will get 100 index cards. You do not have to use all the cards, in fact, you want to construct a strong tower using the least amount of cards.

The cards can be cut, folded, and twisted to achieve your tower goals. You may not use glue, staples, fasteners, tape, or other binding materials in your tower.

Team Materials:

100 3" x 5" Index Cards

Instructions:

1. Read Index Card Tower Design Competition Handout.
2. Ask questions to make sure you understand the rules.
3. Get supplies.
4. Your team has 20 minutes to construct the tower.
5. When time is up, clean up your area and wait for your tower to be tested.

Competition:

A piece of $\frac{1}{4}$ " plywood will be put on top of your tower. Books will be stacked on the plywood until the tower collapses. When the tower collapses, your team and advisor will find the total weight of the plywood, books, and index cards. Using the simple formula below, your team will find the weight carried per card. The team with the most weight per card calculation has built the strongest tower.

Total Weight of plywood, textbooks, and index cards
Carried

Total Number of Index Cards

=

_____ Weight

Card



MESA Mathematics
Engineering
Science
Achievement

Lesson Activity

Week	3, 4, and 6
Sequence of Activities	<p>Week 3</p> <ul style="list-style-type: none"> • Math Puzzle: A Quiz (10 minutes) • MESA Activity: Mousetrap Car (30-45 minutes) • MESA Student Policies and Procedures (20-25 minutes) <p>Week 4</p> <ul style="list-style-type: none"> • Math Puzzle: The Bridge (10 minutes) • MESA Activity: Mousetrap Car (40-55 minutes) • MESA Student AIF Data (10-15 minutes) <p>Week 6</p> <ul style="list-style-type: none"> • Math Puzzle: John and Julia (10 minutes) • MESA Activity: Mousetrap Car (50-70 minutes)
Duration	60-80 minutes
Age Level	High School
Essential Question	How do Newton's 3 Laws of motion affect the motion of my mousetrap car? What kind of modifications can I make to a car that will address the forces of friction and gravity?
Learning Objectives	<p>Math Puzzle</p> <ul style="list-style-type: none"> • TSW solve a logical mathematical word problem using grade appropriate problem solving strategies • TSW solve a multi-step word problem by applying various numerical operations <p>Mousetrap Car</p> <ul style="list-style-type: none"> • TSW identify and recognize Newton's 3 Laws of Motion • TSW describe how Newton's 1st Law affects the motion of an object • TSW describe how we can calculate the force of an object by using the formula $F=ms$ • TSW describe how Newton's 3rd Law affects the motion of an object • TSW design and construct a mousetrap vehicle using given materials • TSW devise a mousetrap car design concept with their partner that is powered by the mousetrap and activated by tripping the original mousetrap trip mechanism • TSW modify their design to improve the overall structure • TSW submit a final mousetrap car that addresses the following challenges: travels the furthest distance up a 30 degree incline and travels 10 meters in the shortest time • TSW evaluate the strengths and weaknesses of their design and their mousetrap car • TSW compare their design concept and their mousetrap car design to those of their peers • TSW describe the process they took to complete the mousetrap car project • TSW explain how Newton's Laws are affecting the motion of their car • TSW calculate the force of their vehicle traveling up the 30 degree incline and calculate the force of their car traveling 10 meters in the shortest time
Other Objectives	<ul style="list-style-type: none"> • TSW develop a working plan with their group to develop a cooperative environment • TSW communicate with their group by contributing their vocal input • TSW listen as their peers discuss the design of their investigation • TSW write down the procedure they used to design their project

Key Terms	<ul style="list-style-type: none"> • Speed • Velocity • Acceleration • Force • Friction • Gravity
Materials Needed	<p>Week 3</p> <p>Math Puzzle</p> <ul style="list-style-type: none"> • Puzzle: A Quiz <p>MESA Activity: Mousetrap Car</p> <p>For Group</p> <ul style="list-style-type: none"> • Toy cars (2) • balloon <p>Per Student</p> <ul style="list-style-type: none"> • Handout: Newton’s 3 Laws of Motion • Handout: Types of Forces <p>Per Team (2-3 students)</p> <ul style="list-style-type: none"> • Handout: Mousetrap Car Competition • Drawing Paper • Colored Pencils <p>MESA Student Policies and Procedures</p> <ul style="list-style-type: none"> • Student Policies and Procedures Handout <p>Week 4</p> <p>Math Puzzle</p> <ul style="list-style-type: none"> • Puzzle: The Bridge <p>MESA Activity: Mousetrap Car</p> <p>For Group</p> <ul style="list-style-type: none"> • Box of assorted materials for teams to use as additional resources <p>Per Student</p> <ul style="list-style-type: none"> • Handout: Mousetrap Car Competition <p>Per team (2-3 students)</p> <ul style="list-style-type: none"> • Team Mousetrap Car Design from Week 3 • 1 Mousetrap • Materials brought from home that fulfill the team’s design <p>MESA Student AIF Data</p> <ul style="list-style-type: none"> • MESA Parent Permission and Student Information Form (AIF) <p>Week 6</p> <p>Math Puzzle</p> <ul style="list-style-type: none"> • Puzzle: John and Julia <p>MESA Activity: Mousetrap Car</p> <ul style="list-style-type: none"> • Handout: MESA Diary <p>For Group</p> <ul style="list-style-type: none"> • Ramp at 30 degree angle to test for power • Track measured out to specification to test for speed • Stopwatch <p>Per Student</p> <ul style="list-style-type: none"> • Handout: MESA Notebook • Handout: Mousetrap Car Competition • Handout: Newton’s 3 Laws of Motion • Handout: MESA Mousetrap Car Speed Competition • Handout: MESA Mousetrap Car Power Competition <p>Per Team (2-3 students)</p> <ul style="list-style-type: none"> • Mousetrap Car • Team Mousetrap Car Design from Week 3
Week 3	<p>Math Puzzle</p> <ol style="list-style-type: none"> 1. Pass out puzzle as students come in for MESA meeting. 2. Tell students they have 5 minutes to try to solve the puzzle and remind them to sign in for attendance.

3. After 5 minutes, discuss math puzzle solutions with class.

Mousetrap Car

1. Pass out Handout: Newton's 3 Laws of Motion
2. Read handout and discuss each law. Use examples to demonstrate how the laws apply to motion.

Examples:

Newton's First Law: Push a toy car across a table. Ask them why it stops. It stops because of friction and gravity, 2 forces acting on the car. If there were no forces acting on the car, it would remain in motion.

Newton's 2nd Law: $f=ma$ You can do a basic comparison. Obviously, the force of an object will increase if either the mass or the acceleration increases. You can use 2 toy cars to demonstrate this. Identical cars at identical masses, except one car is going faster than the other and will contribute to a higher force. You may want to tell them that force is measured in a unit called a Newton.

Newton's 3rd Law: Crawl on a table. Ask students, "Why am I not falling through the table?" The answer is that the table is pushing up on you. Newton's 3rd law states that bodies exhibit equal force on each other. Blow up a balloon. Let it go and watch it fly through the air. Ask students, why does the balloon fly? Where is the force being applied? The air being released from the balloon is pushing against the air on the outside.

3. Ask students to think about other examples of Newton's 3 Laws of Motion. Discuss.
4. Pass out the handout: Types of Forces
5. Discuss handout and ask students to come up with more examples of forces. Add these to the handout.
6. Tell students that they will be building a mousetrap car that will demonstrate Newton's 3 laws of motion. Their car will be acted on by outside forces such as friction and gravity.
7. Pass out handout: Mousetrap Car Competition.
8. Read handout completely as it addresses the rules and specifications for building and competing the cars. Have students retell you in their own words after each section. When discussing the competition aspect of the project, students may ask how far 10 meters is for the speed race. Show them by pointing out a 10 meter distance in the room. If students ask how much a 30 degree angle is, model it for them using objects in the room or the ramp.
9. Tell students that the project will take 3 MESA meetings. You may want to write this on the board. This first meeting will cover the rules and specifications. They will also be designing their vehicle and drawing it on drawing paper. The second meeting will be set aside for building the vehicle. The third meeting will be set aside for testing the vehicle and the actual competition.
10. Have students break up into teams of 2 or 3.
11. Show students a mousetrap and ask them to retell you what they can do with the mousetrap and what they cannot do. Demonstrate how a mousetrap works. Some students already know, but some have not. Discuss the mechanism and ask how the mechanism demonstrates Newton's Laws of Motion. (Newton's 3rd Law- The action of the spring exerts a force that is equal to how hard the clamp closes.)
12. Pass out drawing paper to the teams. Pass out colored pencils. Tell them they have 20-35 minutes to come up with a design. The mousetrap is going to be provided to them. They must bring other objects from home to add to the mousetrap.
13. Write the following questions on the board: What will the wheels be? What can I add to make it go faster? What can I add to make it go up the ramp better? Discuss modifications and how modifications improve a vehicle's performance.
14. Monitor and check student progress. Make sure their concept drawing is addressing competition rules and specifications. Make sure their materials are reasonable things they can easily get from home.
15. Have students add arrows to their drawing that label where friction and gravity

	<p>will be acting on their vehicle. (Friction will be acting on their wheels and gravity will be pushing down on the vehicle.)</p> <ol style="list-style-type: none"> 16. During the last 5 minutes of project time, tell teams to assign materials. Who is going to bring materials for the next meeting? (You may want to follow up this meeting with an email to all MESA students reminding them to bring their materials for the next meeting.) 17. Collect drawing from each team. Collect handouts from each student. 18. Clean up. <p>MESA Student Policies and Procedures</p> <ol style="list-style-type: none"> 1. Review MESA Mission and MESA Calendar. Answer questions they may have. 2. Pass out handouts that give Student Policies and Procedures Overview. 3. Go over what is expected of students and your role in helping them successfully achieve these expectations. 4. Discuss and answer questions.
<p>Week 4</p>	<p>Math Puzzle</p> <ol style="list-style-type: none"> 1. Pass out puzzle as students come in for MESA meeting. 2. Tell students they have 5 minutes to try to solve the puzzle and remind them to sign in for attendance. 3. After 5 minutes, discuss math puzzle solutions with class. <p>Mousetrap Car</p> <ol style="list-style-type: none"> 1. Have students get with their teams. 2. Pass out Handouts to students: Newton's 3 Laws of Motion, Types of Forces and Mousetrap Car Competition. Review with students and have them give you other examples of Newton's 3 Laws and Types of forces. Discuss rules for competition. 3. Pass out team drawings. 4. Have teams get out their supplies that they brought from home. 5. Tell teams that you also have a box of assorted supplies they may use, too. 6. Give them 5 minutes to gather their supplies and to go through your supplies. 7. After 5 minutes, ask teams if they need to modify their drawings based on their supplies. If they do, they may do so now. Pass out colored pencils to the teams that need to modify their design. 8. Tell teams they have 25-40 minutes to build their car. Advise them to work together in their teams and to ask for help from the advisor when they need it. 9. Monitor student progress and check to make sure their car construction follows their design concept closely. 10. If a team gets done constructing their car, they may test it to see if it works. 11. Allow the last 5 minutes for clean up. 12. Have students put their cars in a safe, designated area in your room. <p>MESA Student AIF Data</p> <ol style="list-style-type: none"> 1. Pass out AIF packet. 2. Discuss and clarify the MESA family agreement component. Answer any questions. 3. Encourage students to discuss the parent responsibilities with their family when they get home. 4. Emphasize the importance and conditions of the form. The student needs to understand the meaning of completing the AIF form and how it will affect them. Items to address: access to their school records for data development, usage of their image in pictures for MESA promotion
<p>Week 5</p>	<p>Math Puzzle</p> <ol style="list-style-type: none"> 1. Pass out puzzle as students come in for MESA meeting. 2. Tell students they have 5 minutes to try to solve the puzzle and remind them to sign in for attendance. 3. After 5 minutes, discuss math puzzle solutions with class. <p>Mousetrap Car</p> <ol style="list-style-type: none"> 1. Pass out Handout: Mousetrap Car Competition 2. Discuss competition rules again to clarify. 3. Show them area for Speed competition. Point out dimensions and clarify

	<p>questions. Pass out handout: MESA Mousetrap Car Speed Competition to each student and explain how it needs to be filled out. See sample sheet.</p> <ol style="list-style-type: none"> 4. Show them 30 degree ramp incline for Power Competition. Clarify any questions. Pass out Handout: MESA Mousetrap Car Incline Competition to each student and explain how it needs to be filled out. See sample sheet. 5. Have teams get their cars from designated area. 6. Tell them they have 10-15 minutes to get their cars ready and to test them. 7. When time is up, have each team present their car to the group and point out features they added to make it go faster or stronger. Have group show their original design drawing and point out what modifications they had to make as they began to construct car. Group may ask questions of each team as they present. 8. Have students bring their cars to the speed ramp. 9. Allow students 1 practice run before getting their actual time. 10. Tell students to record each team's time on their MESA Mousetrap Car Speed Competition handout. 11. Discuss winning cars design. What features made it go the fastest? Discuss with group. 12. Move onto the Incline competition. 13. Allow students 1 practice run. 14. As each team gets their run, have teams record distance onto their MESA Mousetrap Car Power Competition handout. Measure in cm and convert to m. 15. Discuss winning cars design. What made it go the furthest up an incline? What could they have done to their car to make it better? 16. Review types of forces that acted on their cars. Ask each team, what did you do to your car to try to overcome the force of friction? What did you do to your car to help it against gravity? 17. Clean up.
Closure	<ol style="list-style-type: none"> 1. Pass out MESA Notebook to each student and have them copy the following terms into the 'key terms' section: Speed, Velocity, Acceleration, Force, Friction, and Gravity. 2. Discuss each term as it applies to the activity and come up with a group definition for each. Make sure students can apply the definition to their experience with their mousetrap cars. 3. Tell students they have the remainder of the time to complete the MESA Notebook. They may work with their team. Write the following 'conclusion' questions on the board and tell them to answer it using what they have learned from the activity: <ul style="list-style-type: none"> • <i>How do Newton's 3 Laws of motion affect the motion of my mousetrap car?</i> • <i>What kind of modifications can I make to a car that will address the forces of friction and gravity?</i> • <i>If I could do this activity again, what changes would I make to my car to make it more competitive?</i> 4. Monitor their progress. 5. Students may complete their MESA Notebook at home.
Informal Assessment	<ul style="list-style-type: none"> • Monitor students as they progress through the project • Monitor students to check for understanding periodically • Informal Oral Presentation of team design and car
Formal Assessment	<ul style="list-style-type: none"> • Completed Mousetrap Car Design • Completed Mousetrap Car • Completed MESA Notebook
Extensions	<ul style="list-style-type: none"> • Math: Use graph paper to graph each team's speed
Trouble Shooting	<ul style="list-style-type: none"> • Have materials ready before students come to the meeting • Email students after meeting 1 and before they come to meeting 2 to remind them to bring their materials. • Have additional mousetraps in case of breakage. • Make sure all students participate in clean up.

SEI Strategies Used

Preparation

- Adaptation of Content
- Links to Background
- Links to Past Learning
- Strategies incorporated

Scaffolding

- Modeling
- Guided practice
- Independent practice
- Comprehensible input

Grouping Options

- Whole class
- Small groups
- Partners
- Independent

Integration of Processes

- Reading
- Writing
- Speaking
- Listening

Application

- Hands-on
- Meaningful
- Linked to objectives
- Promotes engagement

Assessment

- Individual
- Group
- Written
- Oral

Arizona Math Standards Addressed

- S5C1: TSW use reasoning to solve mathematical problems in contextual situations.

Arizona Science Standards Addressed

- S5C2: TSW analyze relationships between forces and motion by explaining how Newton's 1st law applies to objects at rest or moving. Use Newton's 2nd law of motion to analyze the relationships among the force acting on a body and the resulting acceleration, and use Newton's 3rd law to explain the forces as interactions between bodies.



First Law of Motion



According to Newton's first law...

An object at rest will remain at rest unless acted on by an unbalanced force. An object in motion continues in motion with the same speed and in the same direction unless acted upon by an unbalanced force.

This law is often called "the law of inertia".

What does this mean?

This means that there is a natural tendency of objects to keep on doing what they're doing. All objects resist changes in their state of motion. In the absence of an unbalanced force, an object in motion will maintain this state of motion.

This law is the reason why you should always wear your seatbelt.



Second Law of Motion



According to Newton's second law...

Acceleration is produced when a force acts on a mass. The greater the mass (of the object being accelerated) the greater the amount of force needed (to accelerate the object).

What does this mean?

Everyone unconsciously knows the Second Law. Everyone knows that heavier objects require more force to move the same distance as lighter objects.

However, the Second Law gives us an exact relationship between force, mass, and acceleration. It can be expressed as a mathematical equation:

$$F = M A$$

or

FORCE = MASS times ACCELERATION

This is an example of how Newton's Second Law works:

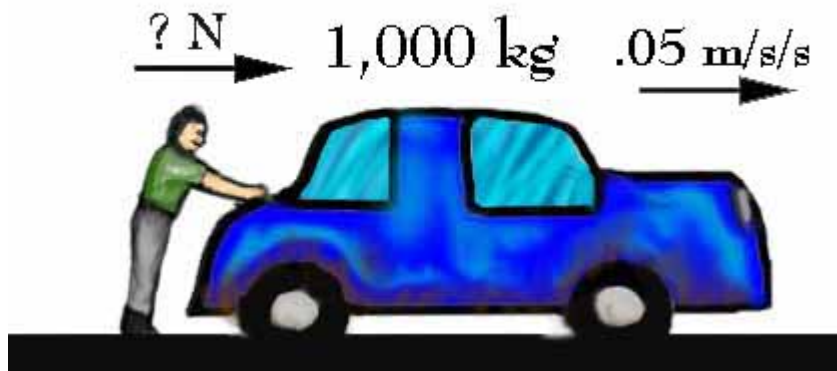

Mike's car, which weighs 1,000 kg, is out of gas. Mike is trying to push the car to a gas station, and he makes the car go 0.05 m/s/s. Using Newton's Second Law, you can compute how much force Mike is applying to the car.

$$F = 1,000 \times 0.05$$

Answer = 50 newtons



Third Law of Motion



According to Newton's third law...

For every action there is an equal and opposite re-action.

What does this mean?

This means that for every force there is a reaction force that is equal in size, but opposite in direction. That is to say that whenever an object pushes another object it gets pushed back in the opposite direction equally hard.

Let's study how a rocket works to understand Newton's Third Law.

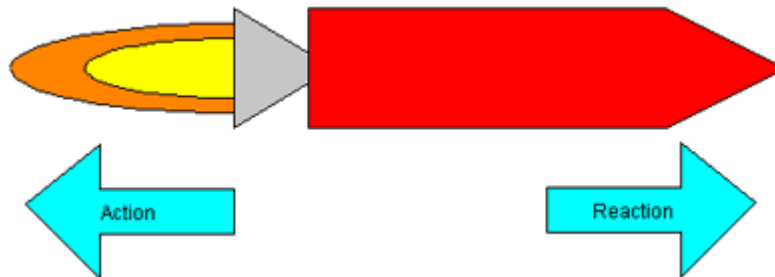

The rocket's action is to push down on the ground with the force of its powerful engines, and the reaction is that the ground pushes the rocket upwards with an equal force.

Source: <http://teachertech.rice.edu/Participants/louviere/Newton/>

Types of Forces

Define the following terms in your own words and try to give examples.

- Gravity:

- Friction:

- Air Resistance:

- Pressure:

Can you come up with other examples?

Mousetrap Car Competition

Goal:

Each team will build one mousetrap car. It must be powered by the mousetrap mechanism and be built to perform the following tasks:

- Speed: Travel 10 meters in the shortest time
- Power: Travel the furthest distance up a 30 degree incline ramp

Materials:

Design Drawing

- Drawing paper
- Colored Pencils

Mousetrap Car

- One standard mousetrap (provided by advisor)
- Any materials decided upon by each team

Instructions:

Day 1:

1. Design your mousetrap car with your team.
2. Draw your design on the drawing paper provided by your advisor. Use colored pencils.
3. Your drawing must show what types of materials are being used in your car.
4. Your drawing must show how friction is acting on your car.
5. Your drawing must show how gravity is acting on your car.
6. Get final approval from your advisor.

Day 2:

1. Check to make sure your team has all the materials needed for your car. If not, you need to modify your drawing.
2. Build your car with your team.
3. Test your vehicle if time permits.

Day 3:

1. Competition day! Follow your teacher's instructions for competition participation.

Rules:

1. The mousetrap car must be solely powered by the mousetrap and activated by tripping the original mousetrap trip mechanism.
2. No other energy source may be added to make the car move. (CO2, batteries, elastic strings, rubber bands, ect..)
3. The mousetrap must be mounted to the chassis.
4. Hardware and other materials may be added to the mousetrap, but the original hardware and mounting block may only be altered to attach it to the vehicle.
5. The mousetrap may not be disassembled and then reassembled.
6. The springs on the mousetrap may not be cut, bent, over-wound, heat treated, or altered in any other manner.
7. No part of the vehicle may be attached to any part of the track or ramp.
8. Vehicle must roll or coast along track or ramp.
9. All wheels must stay in contact with the surface of the track and ramp.

Good Luck and Have Fun!



Mousetrap Car Speed Competition

Directions: Under 'Team', write down the team members names. Under 'Time', write down the recorded time by your advisor. Under 'Speed', use the formula $s=d/t$ to find the time in m/s.

Team	Time in s	Speed in m/s

Math Extension: Use graph paper and graph the speed of each team. Turn in for extra MESA bucks.

Mousetrap Car Power Competition

Directions: Under 'Team', write down the team members names. Under 'Distance in cm', write down the distance recorded by your advisor in cm. Under 'Distance in m', use the following conversion to find distance in m: $1\text{m} = 100\text{cm}$.

Team	Distance in cm	Distance in m

A Quiz...

You are a participant in a quiz. The quizmaster shows you three closed doors. He tells you that behind one of these doors there is a prize, and behind the other two doors there's nothing. You select one of the doors, but before you open it the quizmaster deliberately picks out a remaining empty door and shows that there is nothing behind it. The quizmaster offers you a chance to switch doors with the remaining closed door.

The Question: Should you stick to your choice?

The Bridge

Four men want to cross a bridge. They all begin on the same side. It is night, and they have only one flashlight with them. At most two men can cross the bridge at a time, and any party who crosses, either one or two people, must have the flashlight with them.

The flashlight must be walked back and forth: it cannot be thrown, etc. Each man walks at a different speed. A pair must walk together at the speed of the slower man. Man 1 needs 1 minute to cross the bridge, man 2 needs 2 minutes, man 3 needs 5 minutes, and man 4 needs 10 minutes. For example, if man 1 and man 3 walk across together, they need 5 minutes.

The Question: How can all four men cross the bridge in 17 minutes?

A Quiz...

You are a participant in a quiz. The quizmaster shows you three closed doors. He tells you that behind one of these doors there is a prize, and behind the other two doors there's nothing. You select one of the doors, but before you open it the quizmaster deliberately picks out a remaining empty door and shows that there is nothing behind it. The quizmaster offers you a chance to switch doors with the remaining closed door.

The Question: Should you stick to your choice?

In this puzzle, you should *not* use your intuition, but let your common sense do the job: the chance that your first choice for a door was correct is $1/3$; therefore, the chance that your first choice was wrong is $2/3$.

So the chance that one of the remaining doors is correct is also $2/3$. With the help of the quizmaster (who knows which door hides the price, and thus is able to open one of the remaining doors which does not contain the the price), you get to know which one of the remaining doors is incorrect. Now you also know which one of the remaining doors could be correct with a chance of $2/3$!

Conclusion: You should switch doors, which doubles your chances!...

For the disbelieving few: consider the situation where there are 1000 doors instead of 3. After you have chosen one door, the quizmaster points out 998 of the 999 doors that are left, that do not contain the prize. Should you switch to the other remaining door? Of course! If, out of 999 doors, the quizmaster (deliberately) leaves that door, chances are very large ($999/1000$) that it is the right one!

For the still disbelieving few: write a computer program which simulates this quiz thousands of times, and you will see that the chances are double if you switch doors!...

The Bridge

Four men want to cross a bridge. They all begin on the same side. It is night, and they have only one flashlight with them. At most two men can cross the bridge at a time, and any party who crosses, either one or two people, must have the flashlight with them.

The flashlight must be walked back and forth: it cannot be thrown, etc. Each man walks at a different speed. A pair must walk together at the speed of the slower man. Man 1 needs 1 minute to cross the bridge, man 2 needs 2 minutes, man 3 needs 5 minutes, and man 4 needs 10 minutes. For example, if man 1 and man 3 walk across together, they need 5 minutes.

The Question: How can all four men cross the bridge in 17 minutes?

First man 1 and man 2 walk across the bridge. This takes 2 minutes.

After this, man 1 walks back with the flashlight. This takes 1 minute.

Then man 3 and man 4 walk across the bridge. This takes 10 minutes.

After this, man 2 walks back with the flashlight. This takes 2 minutes.

Then man 1 and man 2 walk across the bridge. This takes 2 minutes as before.

In total: $2+1+10+2+2=17$ minutes.

John & Julia

Julia is as old as John will be when Julia is twice as old as John was when Julia's age was half the sum of their present ages.

John is as old as Julia was when John was half the age he will be 10 years from now.

The Question: How old are John and Julia?

The Solution: **John** is **30** years old and **Julia** is **40** years old.

An explanation:

Let Julia's age be a and let John's age be b .

The first sentence tells us that "Julia is as old as John will be when Julia is twice as old as John was when Julia's age was half the sum of their present ages".

"Half the sum of their present ages" is:

$$0.5*(a+b)$$

So "Julia's age was half the sum of their present ages", the following number of years ago:

$$a - (0.5*(a+b)) = 0.5*a - 0.5*b$$

At that moment, "John's age" was:

$$b - (0.5*a - 0.5*b) = 1.5*b - 0.5*a.$$

So "twice that age" is:

$$3*b - a$$

"Julia's age will be twice that age", in the following number of years:

$$(3*b - a) - a = 3*b - 2*a$$

At that moment, John will be:

$$b + (3*b - 2*a) = 4*b - 2*a$$

And we are told that "that's Julia's age", so:

$$a = 4*b - 2*a$$

or

$$3*a = 4*b.$$

The second sentence tells us that "John is as old as Julia was when John was half the age he will be 10 years from now".

"10 years from now", John will be:

$$b+10$$

"Half that age" is:

$$0.5*b+5$$

"John was that age", the following number of years ago:

$$b - (0.5*b+5) = 0.5*b-5$$

At that time, "Julia was", the following number of years old:

$$a - (0.5*b-5) = a-0.5*b+5$$

And that "is John's current age", so:

$$b = a - 0.5*b + 5$$

or

$$a = 1.5*b - 5.$$

Now we have two equations:

$$3*a = 4*b \text{ and } a = 1.5*b - 5.$$

Substitute a in the first equation for the value of a from the second equation and we get:

$$3*(1.5*b - 5) = 4*b$$

Solving this equation, we get:

$$b=30$$

Since $a = 1.5*b - 5$:

$$a=40$$

So Julia's age is 40, and John's age is 30.

Week	5
Name of Activity	College Track
Duration	60 minutes
Age Level	High School
Essential Question	What do I need to know to be on track for College Admissions
Learning Objectives	<p>Comfort Zone</p> <ul style="list-style-type: none"> • TSW will evaluate their knowledge of college admissions <p>College Track</p> <ul style="list-style-type: none"> • TSW will become familiar with the ABOR Course Work Competency Requirements • TWS will become familiar with their district’s High School Graduation requirements • TSW will become familiar with the Admissions Review Process • TSW will learn common College Admissions terminology
Other Objectives	<ul style="list-style-type: none"> • TSW will identify with other college going students • TSW will create a College Track 4-year plan • TSW will establish some goals for the next 1-4 years of high school
Key Terms	<ul style="list-style-type: none"> • ABOR - Arizona Board of Regents • ABPR Course Work Competency requirements • AP - Advanced Placement • CLEP - College Level Examination Program • Assured Admission • Comprehensive Review
Materials Needed	<ul style="list-style-type: none"> • College Track Handout • UA Admissions Application • College Track Checklist • Rope, tape, or other materials to create large circles • Rolling Admissions Game board - 1 per student • Six-sided die - 1 per student
Lead In	<p>Comfort Zone</p> <ul style="list-style-type: none"> • Create two concentric circles on the floor, big enough for the students to step in and out of. • Explain that the inner circle represents “the comfort zone.” This is a place where you know everything there is to know. Between the outer circle and the inner circle is “the challenge zone.” This is the place where you know a little but need to learn more. Outside of the outer circle is “the starter zone.” This is a place where you know nothing or almost nothing and need to learn the most. • Tell the students that you will announce a topic/category and they must pick which zone they belong to in that topic/category. • To make sure everyone understands start off with some simple examples. Tomorrow’s lunch, addition of whole numbers, Quantum Physics, etc. • End the examples with College Admissions. After the students have selected their zone, let the students know that this is today’s topic. Have them look around to see where everybody is, identify if everyone is in the same boat, if there are students who could be resources for other students, and which students may need to most guidance from their peers. • Continue activity with the following: <ul style="list-style-type: none"> • High School Graduation Requirements • ABOR Course Competency Requirements • Assured Admissions Requirements • PSAT and/or SAT

	<ul style="list-style-type: none"> • ACT • Inform everyone that after today everyone should be on the edge of the comfort zone if not in it with regards to College Admissions.
Activity	<p>College Track</p> <ul style="list-style-type: none"> • Handout MESA Handbook • Ask students to assemble into groups of 3 to 4 students • Tell students to create two lists in the procedure portion of their MESA Handbook. The first list will be their high school graduation requirements. The second list will be the courses required for admission to UA. • Give the students 5 minutes to discuss and create these lists. • After 5 minutes, ask the students to share their lists and write down their responses on the board • Handout College Track handout and compare them to what the students listed. Discuss with the group why there may be differences and where misinformation can come from. Remind them that part of reaching your goals is having complete and accurate information. • Ask the students to share there responses for UA admission and write their responses on the board • Handout UA Admissions Application for 2007-2008. Ask to students to find page which lists the ABOR Course Competency requirements. Explain what ABOR is and how these requirements apply to all in-state public universities. Ask the students to write down ABOR and the ABOR Course Competency Requirements in their MESA Handbooks as terms. • Compare student responses to actual requirements. Make sure the students understand that these requirements ensure that the students will be admissible to any in-state university but that they are not excluded from admission if they do not meet the requirements. • Review and discuss the assured admissions and comprehensive review sections of the application. • Handout "Rolling" Admissions game and dice to students • Play game until everyone completes game card • Ask students if anyone ended in comprehensive review • Discuss what they would need to improve their chances of admission. Ensure that students cover extra-curricular activities, honors/AP courses, leadership experience, work experience, college entrance exam scores and the personal statement • Handout College Track Checklist and inform the students that they will be creating a 4-year plan to ensure that they are on the College Track (on track to meet high school and ABOR course competency requirements)
Closure	<ul style="list-style-type: none"> • Handout College Track checklist to students • Ask the students to take this home and complete it with their parents and create a 4-year plan to stay on the College Track • Ask the students to answer the following questions in the 'conclusion' section of their MESA Handbook: What will my biggest challenge be in completing the college track? What can I do to meet that challenge?
Informal Assessment	<ul style="list-style-type: none"> • Monitor students to check for engagement • Monitor students to check for understanding
Formal Assessment	<ul style="list-style-type: none"> • Completed MESA Handbook • Completed "Rolling" Admissions Game • Completed College Track Check list
Trouble Shooting	<ul style="list-style-type: none"> • Make sure students are participating in comfort zone. If not with group then on paper. • Keep an eye on time. Shorten discussions if necessary to stay on task • Have seniors and/or juniors present workshop to engage them
Extension	<ul style="list-style-type: none"> • More in depth look at Admissions application • Have students complete mock UA admissions applications and bring in an admissions representative to review them for "admission" • Have discussion about taking more than the minimum requirements for major

	<p>specific content areas (i.e. 4th year of science for science majors, additional year of fine arts for fine arts majors)</p> <ul style="list-style-type: none"> • Discussion of alternate way to meet requirements per Admission Applications 						
<p>SEI Strategies Used</p> <table border="0" style="width: 100%;"> <tr> <td style="vertical-align: top; width: 33%;"> <p>Preparation</p> <input type="checkbox"/> Adaptation of Content <input type="checkbox"/> Links to Background <input type="checkbox"/> Links to Past Learning <input type="checkbox"/> Strategies incorporated </td> <td style="vertical-align: top; width: 33%;"> <p>Scaffolding</p> <input type="checkbox"/> Modeling <input type="checkbox"/> Guided practice <input checked="" type="checkbox"/> Independent practice <input type="checkbox"/> Comprehensible input </td> <td style="vertical-align: top; width: 33%;"> <p>Grouping Options</p> <input checked="" type="checkbox"/> Whole class <input checked="" type="checkbox"/> Small groups <input type="checkbox"/> Partners <input checked="" type="checkbox"/> Independent </td> </tr> <tr> <td style="vertical-align: top;"> <p>Integration of Processes</p> <input checked="" type="checkbox"/> Reading <input checked="" type="checkbox"/> Writing <input checked="" type="checkbox"/> Speaking <input checked="" type="checkbox"/> Listening </td> <td style="vertical-align: top;"> <p>Application</p> <input checked="" type="checkbox"/> Hands-on <input checked="" type="checkbox"/> Meaningful <input type="checkbox"/> Linked to objectives <input checked="" type="checkbox"/> Promotes engagement </td> <td style="vertical-align: top;"> <p>Assessment</p> <input type="checkbox"/> Individual <input checked="" type="checkbox"/> Group <input checked="" type="checkbox"/> Written <input type="checkbox"/> Oral </td> </tr> </table>		<p>Preparation</p> <input type="checkbox"/> Adaptation of Content <input type="checkbox"/> Links to Background <input type="checkbox"/> Links to Past Learning <input type="checkbox"/> Strategies incorporated	<p>Scaffolding</p> <input type="checkbox"/> Modeling <input type="checkbox"/> Guided practice <input checked="" type="checkbox"/> Independent practice <input type="checkbox"/> Comprehensible input	<p>Grouping Options</p> <input checked="" type="checkbox"/> Whole class <input checked="" type="checkbox"/> Small groups <input type="checkbox"/> Partners <input checked="" type="checkbox"/> Independent	<p>Integration of Processes</p> <input checked="" type="checkbox"/> Reading <input checked="" type="checkbox"/> Writing <input checked="" type="checkbox"/> Speaking <input checked="" type="checkbox"/> Listening	<p>Application</p> <input checked="" type="checkbox"/> Hands-on <input checked="" type="checkbox"/> Meaningful <input type="checkbox"/> Linked to objectives <input checked="" type="checkbox"/> Promotes engagement	<p>Assessment</p> <input type="checkbox"/> Individual <input checked="" type="checkbox"/> Group <input checked="" type="checkbox"/> Written <input type="checkbox"/> Oral
<p>Preparation</p> <input type="checkbox"/> Adaptation of Content <input type="checkbox"/> Links to Background <input type="checkbox"/> Links to Past Learning <input type="checkbox"/> Strategies incorporated	<p>Scaffolding</p> <input type="checkbox"/> Modeling <input type="checkbox"/> Guided practice <input checked="" type="checkbox"/> Independent practice <input type="checkbox"/> Comprehensible input	<p>Grouping Options</p> <input checked="" type="checkbox"/> Whole class <input checked="" type="checkbox"/> Small groups <input type="checkbox"/> Partners <input checked="" type="checkbox"/> Independent					
<p>Integration of Processes</p> <input checked="" type="checkbox"/> Reading <input checked="" type="checkbox"/> Writing <input checked="" type="checkbox"/> Speaking <input checked="" type="checkbox"/> Listening	<p>Application</p> <input checked="" type="checkbox"/> Hands-on <input checked="" type="checkbox"/> Meaningful <input type="checkbox"/> Linked to objectives <input checked="" type="checkbox"/> Promotes engagement	<p>Assessment</p> <input type="checkbox"/> Individual <input checked="" type="checkbox"/> Group <input checked="" type="checkbox"/> Written <input type="checkbox"/> Oral					
<p>Arizona Math Standards Addressed</p>	<ul style="list-style-type: none"> • Not Applicable 						
<p>Arizona Science Standards Addressed</p>	<ul style="list-style-type: none"> • Not Applicable 						



“Rolling” Admissions

<u>ABOR Course Competency</u>		2.0	Extra
English (4)	□ □ □ □	□	
Math (4)	□ □ □ □	□	
Science (3)	□ □ □ □	□	
Soc Studies (2 + 1 _{HS})	□ □ □ □	□	
Foreign Language (2)	□ □ □ □	□	
Fine Arts (1)	□ □ □ □	□	
	Top 25%	□	

- HS Grad** – Did you meet your graduation requirements? Assume you have all of your electives.
- ABOR Course Competency** – Have you taken all 16 course competency requirements?
Engl – 4, Math – 4, Science – 3, Social Studies – 2, Foreign Language – 2, Fine Arts – 1
- Assured Admission** – Did you meet course competency requirements, the minimum 2.0 GPA in each subject area, and are in the Top 25% of your class? If so, congratulations you are assured admission to the UA!
- Comprehensive Review** – If you did not get assured admission don’t worry, you can still be admitted to the university. In fact most of this year’s freshman class were admitted through comprehensive review. Let your admissions application prove you are college ready.

Rules:

Units

1. Roll a six-sided die
2. Result = # of units available
3. Choose a course competency category and use as many of the available units you would like. Place any left over units into the extra box.
(example - If you roll a 5, you could put 4 units into Math and the remaining unit would go into extra.)
4. Repeat steps 1-5 until you have rolled for each course competency category.
5. Use the Extra to complete your course competency for university admissions and high school graduation (example – your extra Math unit could be used to complete your Science units if you rolled a 2 for Science)

Grades

6. Roll the die once for each course competency category
7. If you roll at 2, 3, 4 or 5 put a check in the 2.0 box for that category.
8. If you roll a 6 check the 2.0 box for all categories and check the TOP 25% box. Congrats Brainiac! Skip to step 10.
9. Repeat steps 6 and 7 until you have rolled for each competency category or have rolled a six.

Graduation & Admissions

10. Complete the checklist



College Track Checklist

College Track Courses

*Required for College Track (High School Graduation & University Course Competency)

English	Class	Grade	Honors/AP
*1.			
*2.			
*3.			
*4.			
GPA			

Math	Class	Grade	Honors/AP
*1.	Algebra I		
*2.	Geometry		
*3.	Algebra II		
*4.			
GPA			

Science	Class	Grade	Honors/AP
*1.			
*2.			
*3.			
4.			
GPA			

Social Studies	Class	Grade	Honors/AP
*1.	American History		
*2.			
*3.			
4.			
GPA			

Foreign Language	Class	Grade	Honors/AP
*1.			
*2.			
3.			
4.			
GPA			

Fine Arts	Class	Grade	Honors/AP
*1.			
2.			
3.			
4.			
GPA			

Electives

1.		7.
2.		8.
3.		9.
4.		10.
5.		11.
6.		12.

**The University of Arizona
Office of Early Academic Outreach
District Graduation & University Admission Requirements**

Amphitheater

Required Classes	Middle School Units/Years	High School Graduation Requirements Units/Years	University Admission Requirements Credits/Years	College Track High School Graduation & University Admission Requirements
English	3.0	4.0	4.0	4.0
Math	3.0	2.0/3.0*	4.0	4.0
Science	3.0	2.0/3.0*	3.0	3.0
Social Studies American Economic Systems U.S. / Arizona Government U.S./Arizona History World History/Geography	3.0	0.5 0.5 1.0 <u>1.0</u> 3.0	2.0 American History Required	3.0
Foreign Language	Determined by School	N/A	2.0 Same Language	2.0 Same Language
Fine Arts or Vocational Ed	Determined by School	1.0	1.0 Fine Arts Only	1.0 Fine Arts Only
Physical Education	Determined by School	1.5	N/A	1.5
Electives	Determined by School	6.5	N/A	6.5
Total Units/Credits/Years	Total Determined by School	20.0	16.0	25.0

* 3.0 units will be required for the Class of 2010 and all subsequent classes

NOTE: The requirements stated above are the minimum district requirements. Each middle and high school has the flexibility to add other classes to their curriculum. Honors and AP classes are highly recommended for college preparation.

**The University of Arizona
Office of Early Academic Outreach
District Graduation & University Admission Requirements**

Flowing Wells

Required Classes	Middle School Units/Years (7th & 8th Grade Only)	High School Graduation Requirements Units/Years “Blue Diploma”	University Admission Requirements Credits/Years	College Track High School Graduation & University Admission Requirements “Gold Diploma”
English	2.0	4.0	4.0	4.0
Math	2.0	3.0	4.0	4.0
Science	2.0	2.0	3.0	3.0
Social Studies Global Studies, Economics, U.S. History and U.S. Government	2.0	3.5	2.0 American History Required	3.5
Health/Driver’s Ed/Life Rec	N/A	1.0	N/A	1.0
Foreign Language	Determined by School	1.0	2.0 Same Language	2.0 Same Language
Fine Arts or Vocational Ed	Determined by School	1.0	1.0 Fine Arts Only	1.0 Fine Arts Only
Physical Education	2.0	N/A	N/A	N/A
Learn to Learn	2.0	N/A	N/A	N/A
Electives	Determined by School	6.5	N/A	6.5
Total Units/Credits/Years	Total Determined by School	22.0	16.0	25.0

NOTE: The requirements stated above are the minimum district requirements. Each middle and high school has the flexibility to add other classes to their curriculum. Honors and AP classes are highly recommended for college preparation.

**The University of Arizona
Office of Early Academic Outreach
District Graduation & University Admission Requirements**

Indian Oasis

Required Classes	Middle School Units/Years	High School Graduation Requirements Units/Years	University Admission Requirements Credits/Years	College Track High School Graduation & University Admission Requirements
English	3.0	4.0	4.0	4.0
Math	3.0	3.0	4.0	4.0
Science	3.0	2.0	3.0	3.0
Social Studies U.S. History, AZ Govt, Free Enterprise, World History, Tohono O'odham History (1/2)	3.0	4.0	2.0 American/U.S. History Required	4.0
Foreign Language Tohono O'odham	Determined by School	N/A	2.0 Same Language	2.0 Same Language
Health	Determined by School	.05	N/A	.05
Driver's Education	N/A	.05	N/A	.05
Fine Arts or School To Work	Determined by School	1.0	1.0 Fine Arts Only	1.0 Fine Arts Only
Physical Education	Determined by School	1.0	N/A	1.0
Electives	Determined by School	6.0	N/A	6.0
Total Units/Credits/Years	Total Determined by School	22.0	16.0	26.0

NOTE: The requirements stated above are the minimum district requirements. Each middle and high school has the flexibility to add other classes to their curriculum. Honors and AP classes are highly recommended for college preparation.

**The University of Arizona
Office of Early Academic Outreach
District Graduation & University Admission Requirements**

Nogales

Required Classes	Middle School Units/Years	High School Graduation Requirements Units/Years	University Admission Requirements Credits/Years	College Track High School Graduation & University Admission Requirements
English	3.0	4.0	4.0	4.0
Math	3.0	2.0	4.0	4.0
Reading	3.0	Built into English classes	N/A	N/A
Science	3.0	2.0	3.0	3.0
Social Studies U.S. /Arizona History World History/Geography U.S./Arizona Government & Free Enterprise	Determined by School	1.0 1.0 <u>1.0</u> 3.0	2.0 American History Required	3.0
Foreign Language (Spanish)	Determined by School	1.0	2.0 Same Language	2.0 Same Language
Fine Arts or Vocational Ed	Determined by School	1.0	1.0 Fine Arts Only	1.0 Fine Arts Only
Physical Education	Determined by School	1.0	N/A	1.0
Computer Class	Determined by school	1.0	N/A	1.0
Electives	Determined by School	7.0	N/A	6.0
Total Units/Credits/Years	Total Determined by School	22.0	16.0	25.0

NOTE: The requirements stated above are the minimum district requirements. Each middle and high school has the flexibility to add other classes to their curriculum. Honors and AP classes are highly recommended for college preparation.

**The University of Arizona
Office of Early Academic Outreach
District Graduation & University Admission Requirements**

Sunnyside

Required Classes	Middle School Units/Years	High School Graduation Requirements Units/Years	University Admission Requirements Credits/Years	College Track High School Graduation & University Admission Requirements
English	3.0	4.0	4.0	4.0
Math	3.0	2.0	4.0	4.0
Science	3.0	2.0	3.0	3.0
Social Studies U.S. and Arizona History World History/Geography American Government American Economic Institutions	3.0	1.0 1.0 0.5 <u>0.5</u> 3.0	2.0 American History Required	3.0
Foreign Language	Determined by School	N/A	2.0 Same Language	2.0 Same Language
Fine Arts or Vocational Ed	Determined by School	1.0	1.0 Fine Arts Only	1.0 Fine Arts Only
Health	Determined by School	0.5	N/A	0.5
Physical Education	Determined by School	1.0	N/A	1.0
Electives	Determined by School	6.5	N/A	6.5
Total Units/Credits/Years	Total Determined by School	20.0	16.0	25.0

NOTE: The requirements stated above are the minimum district requirements. Each middle and high school has the flexibility to add other classes to their curriculum. Honors and AP classes are highly recommended for college preparation.

**The University of Arizona
Office of Early Academic Outreach
District Graduation & University Admission Requirements**

TUSD

Required Classes	Middle School Units/Years	High School Graduation Requirements Units/Years	University Admission Requirements Credits/Years	College Track High School Graduation & University Admission Requirements
English	3.0*	4.0	4.0	4.0
Math	3.0*	3.0	4.0	4.0
Science	3.0*	2.0	3.0	3.0
Social Studies American & Arizona History, American & Arizona Constitutions, Government, World History/Geography	3.0*	3.0	2.0 American History Required	3.0
Foreign Language	Determined by School	N/A	2.0 Same Language	2.0 Same Language
Fine Arts or Vocational Ed	Determined by School	1.0	1.0 Fine Arts Only	1.0 Fine Arts Only
Physical Education	Determined by School	1.0	N/A	1.0
Health	Determined by School	0.5	N/A	0.5
Electives	Determined by School	6.5	N/A	6.5
Total Units/Credits/Years	Total Determined by School	21.0	16.0	25.0

*3 years recommended

NOTE: The requirements stated above are the minimum district requirements. Each middle and high school has the flexibility to add other classes to their curriculum. Honors and AP classes are highly recommended for college preparation.



MESA
Mathematics
Engineering
Science
Achievement

Lesson Activity

Week	7
Sequence of Activities	<ul style="list-style-type: none"> • Math Puzzle: The Masters Plaza (20-25 minutes) • MESA Activity: Cantilever (40-55 minutes)
Duration	60-80 minutes
Age Level	High School
Essential Question	How does a cantilever's design allow it to project over something without crashing?
Learning Objectives	<p>Math Puzzle</p> <ul style="list-style-type: none"> • TSW solve a logical mathematical word problem using grade appropriate problem solving strategies • TSW solve a multi-step word problem by applying various numerical operations <p>Cantilever</p> <ul style="list-style-type: none"> • TSW identify, define, and apply the term 'cantilever' • TSW illustrate and explain the basic cantilever concept • TSW recognize various cantilever structures • TSW design and construct a cantilever using given materials • TSW modify their construction to improve the overall structure • TSW evaluate the strengths and weaknesses of their cantilever • TSW compare their cantilever to their peers • TSW describe the process they took to complete the cantilever • TSW identify some of the uses for cantilevers in today's society
Other Objectives	<ul style="list-style-type: none"> • TSW communicate with their group by contributing their vocal input • TSW listen as their peers discuss the construction of their cantilever • TSW write down the procedure they used to design their project
Key Terms	<ul style="list-style-type: none"> • Cantilever • Projecting
Materials Needed	<p>Math Puzzle</p> <ul style="list-style-type: none"> • Handout: The Masters Plaza <p>Cantilever</p> <p>Per Student</p> <ul style="list-style-type: none"> • Handout: Cantilevers • Handout: MESA Notebook <p>Per Team (2 students)</p> <ul style="list-style-type: none"> • Cantilever Competition • 10 popsicle sticks • 15 paperclips • 5 straws • 2 meters of masking tape • 10 pipe cleaners • 2 sheets of newspaper
Lead In	<p>Math Puzzle</p> <ol style="list-style-type: none"> 4. Pass out puzzle as students come in for MESA meeting. 5. Tell students they have 20 minutes to try to solve the puzzle and remind them to sign in for attendance. 6. After 20 minutes, discuss math puzzle solutions with class. 7. Collect MESA Notebook handout from students and discuss 'conclusion' questions.
Activity	<p>Cantilever</p> <ol style="list-style-type: none"> 1. Pass out 'Cantilevers' handout. 2. Give students time to look at the images to speculate what a cantilever is. 3. After 5 minutes, write the term 'cantilever' on the board. Pass out MESA Notebook while they are looking at the images. 4. Ask students to come up with characteristics that cantilevers have in common.

	<p>Guide them to a common idea.</p> <ol style="list-style-type: none"> 5. When the class agrees, ask them to come up with a definition of a cantilever. Guide their discussion and write common definition on the board. Some student definitions may include: <ul style="list-style-type: none"> • a part of an object that sticks out • a part of a structure that hangs over the edge 6. Tell them to write this definition in the 'key terms' section of their Notebook. 7. Write the following actual definition on the board: <ul style="list-style-type: none"> • A projecting beam or member supported at only one end 8. Discuss the student's definition with the dictionary definition. Compare to give students a complete understanding of a cantilever. 9. Write the term 'projecting' on the board and have them come up with a common definition. Write this on the board and have them copy it in the 'key terms' section of their MESA Notebook. 10. Ask, "Why do you think that a cantilever can project over something like a building or water without crashing into it?" Discuss possibilities and guide students to a common understanding. <div style="border: 1px solid black; padding: 10px; margin: 10px 0;"> <p><i>A cantilever is supported because one end has more weight on it. The most stable cantilevers are short. Brackets can be used to support cantilevers. Sometimes, as the cantilever arm extends out, it gets narrower so that a bulk of the weight and support is near the base.</i></p> </div> <ol style="list-style-type: none"> 11. Ask students to remember other objects they have seen that they can now identify as a cantilever. Solicit answers and discuss. 12. Ask, "Looking at the pictures and what you know about cantilevers, why are they important to us? How are they useful?" 13. Pass out the handout 'Cantilever Competition'. 14. Read handout and check for understanding by having students retell directions in their own words. 15. Tell students they have 15-35 minutes to build a cantilever with the given materials. 16. Have students get into teams and pass out the materials. 17. Monitor students while they build their cantilevers. Check to make sure they are following the rules and guidelines of the competition. 18. When time is up, have students quickly clean up. 19. Have students look at all the teams' cantilevers and compare to their own. 20. Get a measuring tape and measure how far out the cantilever extends from the table. 21. When a team winner has been announced, discuss that team's design.
Closure	<ol style="list-style-type: none"> 1. Ask each team, "What would you do differently if you could do this activity again?" Let each team reflect on their design and their successes. 2. Have students take out their MESA Notebook. 3. Tell them to complete the 'materials used' section, the 'procedure' section, and the 'conclusion' section at home. 4. Write the following conclusion question on the board: How does a cantilever's design allow it to project over something without crashing?
Informal Assessment	<ul style="list-style-type: none"> • Monitor students for understanding • Monitor students to check for participation • Oral evaluation of their project and what they would do differently
Formal Assessment	<ul style="list-style-type: none"> • Completed cantilever • Completed MESA Notebook
Trouble Shooting	<ul style="list-style-type: none"> • Make sure all materials are ready before activity begins • Make sure all students get the same amount/size of newspaper • Make sure students do not share their materials

SEI Strategies Used

Preparation

- Adaptation of Content
- Links to Background
- Links to Past Learning
- Strategies incorporated

Scaffolding

- Modeling
- Guided practice
- Independent practice
- Comprehensible input

Grouping Options

- Whole class
- Small groups
- Partners
- Independent

Integration of Processes

- Reading
- Writing
- Speaking
- Listening

Application

- Hands-on
- Meaningful
- Linked to objectives
- Promotes engagement

Assessment

- Individual
- Group
- Written
- Oral

Arizona Math Standards Addressed

- S5C1: TSW use reasoning to solve mathematical problems in contextual situations.

Arizona Science Standards Addressed

- S1C4: TSW communicate the results of their investigation.

The Masters Plaza

You have the chance to take your room in the "Masters Plaza", a hotel in which 5 masters (5 of the most intelligent people who ever lived) are present. The hotel consists of 5 rooms and a small restaurant that contains 5 tables. Each master has a rank which shows his level of thinking with respect to the whole group. The master with the first rank is said to be the head master, and he is not you. Rooms, as well as tables, are successively numbered from 1 to 5 in a way that each master lives in a room and eats on a table different in number from his rank. To avoid confrontation, masters with successive ranks are neither allowed to live in rooms next to each other nor to eat on tables next to each other. The four present masters are: Albert Einstein, Galileo Galilei, Hassan Issa and Archimedes. To have your room in the Plaza, you just have to know your rank, table number and room number knowing that:

Archimedes doesn't eat on the fifth table.

Einstein is not the head master.

Archimedes has exactly the middle rank between Hassan and You.

Einstein is more intelligent than Archimedes.

Galileo eats on a table next to that of Einstein.

Hassan does not eat on a table with the same number as his room number.

The Question: What are the ranks, room numbers, and table numbers of the five masters?

Solution:

The first step is to know the ranks of the 5 masters.

Archimedes has a middle rank between *Hassan* and *You*. Then *Archimedes* has the 2nd, 3rd or 4th rank.

If *Archimedes* is in the 2nd rank then *Hassan* has the first and *You* have the 3rd rank. So *Einstein* can't have a higher rank than *Archimedes*, so this possibility is false.

If *Archimedes* has the 4th rank then *Hassan* and *You* are in the 3rd and 5th rank, so *Galileo* and *Einstein* have the 1st and the 2nd rank which is impossible because they eat on tables next to each other.

If *Archimedes* has the 3rd rank and *Hassan* and *You* have the 2nd and the 4th rank then *Einstein* has the 1st rank and *Galileo* has the 5th, because *Einstein* is more intelligent than *Archimedes*, and that is impossible because *Einstein* is not the head master.

The only true possibility is that *Archimedes* has the 3rd rank, *Hassan* has the 1st and *You* the 5th, because *You* are not the headmaster. Then *Einstein* has the 2nd rank and *Galileo* the 4th, because *Einstein* is more intelligent than *Archimedes*.

The second step is to list all the possibilities for successive ranks so that they are not next to each other.

Table/room number	1	2	3	4	5	Result
Ranks	1	3	5	2	4	Rejected
	1	4	2	5	3	Rejected
	2	4	1	3	5	Rejected
	2	4	1	5	3	Accepted
	2	5	3	1	4	Rejected
	3	1	4	2	5	Rejected
	3	1	5	2	4	Accepted
	3	5	1	4	2	Rejected
	3	5	2	4	1	Rejected
	4	1	3	5	2	Rejected
	4	2	5	1	3	Rejected
	4	2	1	3	5	Rejected
	5	2	4	1	3	Rejected
	5	3	1	4	2	Rejected

Here two possibilities are true as shown in the table but *Archimedes* (rank 3) doesn't eat on the 5th table, so the 1st possibility is not the table number. The 2nd possibility is true in table and room numbers case, but since *Hassan* does not eat on a table with the same number as his room number, then the 2nd possibility is for the table number and the 1st for the room number. The results are shown in this table:

	Hassan	Einstein	Archimedes	Galileo	You
Rank	1	2	3	4	5
Table number	2	4	1	5	3
Room number	3	1	5	2	4

Cantilevers

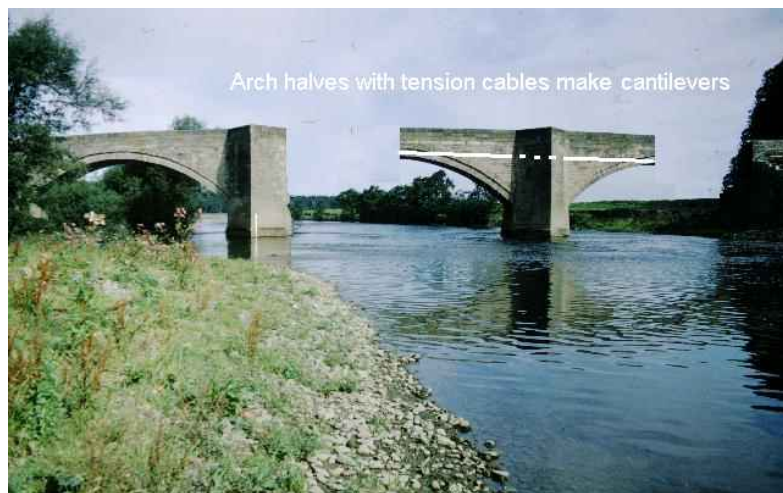
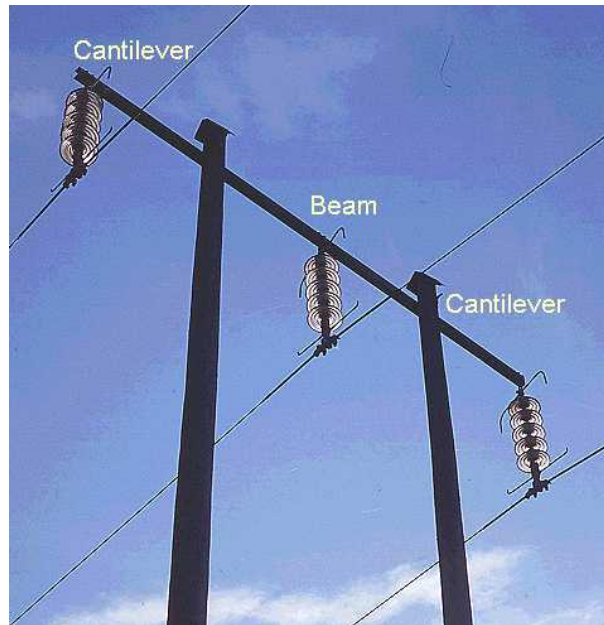



This tree is showing a natural cantilever. But, it is being supported by the 2 braces.

Cantilever Competition

Goal:

- Each team will build one cantilever using the given materials that will extend as far as possible off the table.
- The cantilever will stay on the table with its own weight and will not be fastened to the table with clay, glue, or tape.

Materials:

- 10 popsicle sticks
- 15 paperclips
- 5 straws
- 2 meters of masking tape
- 10 pipe cleaners
- 2 sheets of newspaper

Instructions:

1. Discuss cantilevers and cantilever designs with the group.
2. Read the 'Cantilever Competition' handout. Ask questions to make sure you understand the rules.
3. Get into teams of 2-3 students.
4. Get your supplies from the advisor.
5. Brainstorm with your team to quickly come up with a design that incorporates the given materials. Use what you have learned in the cantilever discussion.
6. Begin constructing your cantilever. Your advisor will tell you how much time you have.
7. When time is up, watch as the advisor measures how far out your cantilever projects off the table.

Rules:

1. You may not use clay or tape to keep your cantilever on the table. It must be supported by its own weight.
2. You may not share your materials with the other teams. You do not have to use all your materials, but you cannot give away materials you are not using.

Good Luck and Have Fun!

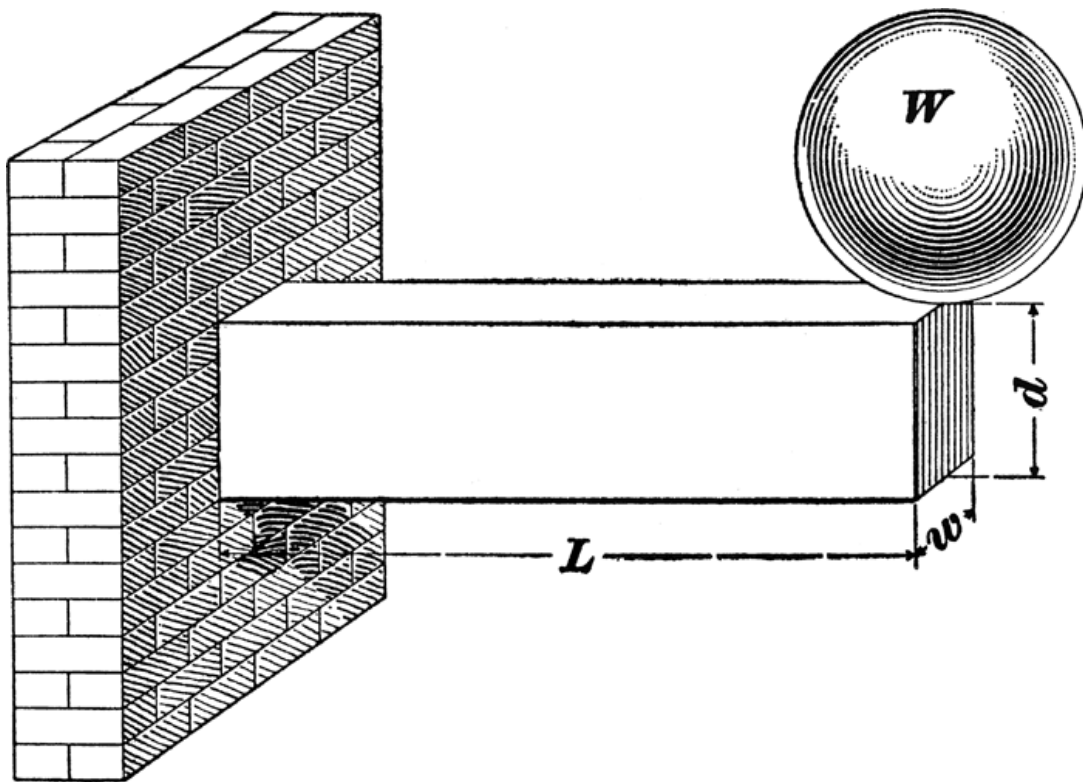

Week	1
Suggested Sequence of Activities	<ul style="list-style-type: none"> • Icebreaker Activity (Teacher will select) 10-15 minutes • Really Cold Activity (Teacher Demonstration) 10-15 minutes • Making Ice Cream (30-35 minutes) • Introduction to MESA (15 minutes)
Duration	60-80 Minutes
Age Level	Middle School
Essential Question	How does the concept of endothermic melting help to make ice cream?
Learning Objectives	<p>Making Ice Cream:</p> <ul style="list-style-type: none"> • TSW visualize how salt affects the endothermic melting of ice • TSW compare and differentiate the different states of matter • TSW define, recall, and apply their understanding of the term 'freezing point depression' • TSW describe how the process of endothermic melting makes ice cream
Other Objectives	<ul style="list-style-type: none"> • TSW develop a working plan with their group to develop a cooperative environment • TSW communicate with their group by contributing their vocal input
Key Terms	<ul style="list-style-type: none"> • Freezing point depression • Mixture • Solid • Liquid • Gas • Absorption of heat
Materials Needed	<p>Really Cold Activity Teacher Demonstration</p> <ul style="list-style-type: none"> • 1 Ice Cube • 1 teaspoon of salt • 25 cm of string <p>Making Ice Cream (per 1 student)</p> <ul style="list-style-type: none"> • Recipe posted on wall or handed out • ½ cup milk • ½ teaspoon vanilla • 1 tablespoon sugar • 4 cups crushed ice • 4 tablespoons salt • 2 quart size Zip-loc bags • 2 gallon size Zip-loc freezer bags • 1 plastic spoon • Paper towels
Lead In	<p>Ice Breaker Activity (on your own)</p> <p>Teacher Demonstration of Really Cold Activity</p> <ol style="list-style-type: none"> 1. Put a wet string on top of the ice cube. 2. Put salt on top of the string. 3. Let it sit for 1 minute. 4. Ask students what they think is going to happen. Discuss answers. 5. Pick up ice cube with the string. 6. Ask students to explain what they think happened. Discuss answers. 7. Write the following terms on the board: solid, liquid, gas 8. Students will define in their own words each term and give examples of each. 9. Write states of matter on the board and connect it to solid, liquid, and gas. Discuss for clarity. 10. Redirect students to the demonstration. Ask, would the string still pick up the ice cube if we didn't use salt? Solicit answers and discuss. 11. Ask, "What do you think the salt does that makes the string stick to ice cube?"

	<p>You can lead them to the answer by asking, why do things freeze? What does it mean to freeze? (Students may respond by saying, "there is a lack of heat", "the molecules stop moving", etc... Use all their responses to guide the discussion. Introduce following term and concept: endothermic process.</p> <div style="border: 1px solid black; padding: 5px; margin: 10px 0;"> <p><i>The melting of ice is an endothermic process. Endothermic means that it takes heat from its surroundings. The temperature of the surroundings decreases. When salt is sprinkled on the string and the ice cube, some of the ice melts. As it melts, it absorbs heat from its surroundings, which included the damp string. as the string loses heat, the water in the string freezes causing it to attach to the ice cube.</i></p> </div>			
Activity	<p>Making Ice Cream</p> <ol style="list-style-type: none"> 1. Ask students what their favorite ice cream flavor is. Discuss. 2. Ask students to describe how ice cream is made. Discuss. 3. Pass out the instructions for making ice cream. See Attachment. 4. Pass out materials to each group. 5. Have students read instructions individually. 6. Have students retell the directions in their own words by calling on students at random to describe the steps sequentially. 7. Allow 15 minutes for them to make ice cream. 8. Clean up. 			
Closure	<ol style="list-style-type: none"> 1. Gather students together while they eat their ice cream. 2. Guide students to previous demonstration. Ask, "how could salt help to make ice cream?" Refer students to conclusion question #1 and tell them to write down an answer based on the discussion. 3. Redirect students to previous question of "How do things freeze?" and the term endothermic process. Refer students to the conclusion question #2 and tell them to write down an answer based on the discussion. 4. Guide discussion until students can apply the concepts of endothermic freezing to the making of their ice cream. <p>Introduction to MESA</p> <ol style="list-style-type: none"> 1. Ask students why they joined MESA. 2. Ask students what they think MESA is about and what they think they will be doing at MESA meetings. 3. Introduce and discuss what MESA is about and how it will make them more successful in various aspects of their life. 4. Have a former member of MESA describe their experiences with MESA and allow students the opportunity to ask questions. 5. Inform students of the next MESA meeting and give them a heads up that the next activity is called "Toothpick Dome". 			
Informal Assessment	<ul style="list-style-type: none"> • Monitor students to check for understanding of terminology and its application to the activity. • Monitor the students to check for participation. 			
Formal Assessment	<ul style="list-style-type: none"> • Students should have created acceptable tasting ice cream for their group • Conclusion questions on handout 			
Trouble Shooting	<ul style="list-style-type: none"> • Make sure each group has instructions • Make sure they are measuring correctly • Make sure they shake bags gently • Monitor to check for clean up 			
<p>SEI Strategies Used</p> <table style="width: 100%; border: none;"> <tr> <td style="width: 33%; vertical-align: top;"> <p>Preparation</p> <input type="checkbox"/> Adaptation of Content <input type="checkbox"/> Links to Background </td> <td style="width: 33%; vertical-align: top;"> <p>Scaffolding</p> <input type="checkbox"/> Modeling <input type="checkbox"/> Guided practice </td> <td style="width: 33%; vertical-align: top;"> <p>Grouping Options</p> <input type="checkbox"/> Whole class <input type="checkbox"/> Small groups </td> </tr> </table>		<p>Preparation</p> <input type="checkbox"/> Adaptation of Content <input type="checkbox"/> Links to Background	<p>Scaffolding</p> <input type="checkbox"/> Modeling <input type="checkbox"/> Guided practice	<p>Grouping Options</p> <input type="checkbox"/> Whole class <input type="checkbox"/> Small groups
<p>Preparation</p> <input type="checkbox"/> Adaptation of Content <input type="checkbox"/> Links to Background	<p>Scaffolding</p> <input type="checkbox"/> Modeling <input type="checkbox"/> Guided practice	<p>Grouping Options</p> <input type="checkbox"/> Whole class <input type="checkbox"/> Small groups		

<input checked="" type="checkbox"/> Links to Past Learning <input checked="" type="checkbox"/> Strategies incorporated Integration of Processes <input checked="" type="checkbox"/> Reading <input type="checkbox"/> Writing <input checked="" type="checkbox"/> Speaking <input checked="" type="checkbox"/> Listening		<input checked="" type="checkbox"/> Independent practice <input checked="" type="checkbox"/> Comprehensible input Application <input checked="" type="checkbox"/> Hands-on <input checked="" type="checkbox"/> Meaningful <input checked="" type="checkbox"/> Linked to objectives <input checked="" type="checkbox"/> Promotes engagement		<input checked="" type="checkbox"/> Partners <input checked="" type="checkbox"/> Independent Assessment <input checked="" type="checkbox"/> Individual <input type="checkbox"/> Group <input type="checkbox"/> Written <input checked="" type="checkbox"/> Oral	
Arizona Math Standards Addressed	<ul style="list-style-type: none"> • None 				
Arizona Science Standards Addressed	<ul style="list-style-type: none"> • S1C2: Conduct controlled investigations using safe behavior and appropriate procedures. • S1C4: Communicate and the conclusions of the investigation. • S5C1: Understand physical properties of matter. Identify different kinds of matter based on their physical properties. Investigate how the transfer of energy can affect the physical properties of matter. 				

Making Ice Cream

Goal:

Your will make edible ice cream using the supplied materials.

Team Materials:

- ½ c. milk
- ½ tsp. vanilla
- 1 tbs. sugar
- 4 c. crushed ice
- 4 tbs. salt
- 2 quart sized Zip-Loc bags
- 1 gallon sized Zip-Loc freezer bags
- Paper towel

Instructions:

1. Gather supplies from your advisor.
2. Mix the milk, vanilla, and sugar together in one of the quart size Zip-Loc bags.
3. Get as much air out of the bag as you can and seal the bag tightly. If there is a lot of air in the bag, it will open and your ice cream will be ruined.
4. Put the quart size bag inside the second quart size bag. Get as much air out of the second bag as you can and seal it tightly.
5. Put these 2 bags inside the gallon sized Zip-Loc freezer bag.
6. Add the ice to the gallon sized Zip-Loc freezer bag.
7. Sprinkle the salt on top of the ice.
8. Get as much air out of the gallon sized Zip-Loc freezer bag as you can and seal it tightly.
9. Wrap the bag in paper towel.
10. Shake the bag gently. Massage the bag gently for 5-8 minutes. Make sure the ice surrounds the cream mixture.

Conclusion Question:

1. Why do you think we double bagged the cream mixture?

2. How does the salt help to make ice cream? Use what you learned about the 'endothermic process'.





Lesson Activity

Week	2
Suggested Sequence of Activities	<ul style="list-style-type: none"> • Math Puzzles: Hans and Gerrie, Birthday Cake (15 minutes) • Toothpick Dome (40-45 minutes) • MESA Calendar (15-20 minutes)
Duration	70-80 minutes
Age Level	Middle School
Essential Question	What makes a geodesic dome strong?
Learning Objectives	<p>Math Puzzles</p> <ul style="list-style-type: none"> • TSW solve higher order math logic puzzles using grade level problem solving strategies • TSW use reasoning to solve mathematical logic puzzles using given information <p>Toothpick Dome</p> <ul style="list-style-type: none"> • TSW identify the triangle as a very stable shape used in engineering and construction • TSW describe qualities that make a triangle very stable • TSW identify the weak point in a triangle (joint area) • TSW apply their understanding of triangular strength to the engineering of a geodesic dome • TSW discuss, re-explain, and demonstrate how a geodesic dome distributes the weight load over all the different triangles that compose it • TSW apply their overall understanding of geodesic domes to design and construct one using the given materials in the given time • TSW describe the construction process of their dome and evaluate its strengths and weaknesses by comparing it to other domes constructed by their peers
Other Objectives	<ul style="list-style-type: none"> • TSW develop a working plan with their group to develop a cooperative environment • TSW communicate with their group by contributing their vocal input
Key Terms	<ul style="list-style-type: none"> • Logical thinking • Geodesic dome • Polygon • Triangle • Compression • Tension • Weight distribution
Materials Needed	<p>Math Puzzles</p> <ul style="list-style-type: none"> • Handout with logic puzzles: Hans and Gerrie and Birthday Cake <p>Geodesic Dome</p> <p>Per Group</p> <ul style="list-style-type: none"> • Pictures of some geodesic domes: Epcot, Biosphere <p>Per student</p> <ul style="list-style-type: none"> • Handout: MESA Notebook <p>Per team (2-3 students)</p> <ul style="list-style-type: none"> • 100 round toothpicks • 30-40 small marshmallows or gum drops <p>MESA Calendar</p> <ul style="list-style-type: none"> • MESA Calendar Handouts or Overhead
Lead In	<p>Math Puzzles</p> <ol style="list-style-type: none"> 1. Pass puzzles out to students as they arrive for MESA meeting. Remind them to sign in on attendance sheet. 2. Inform students that they may work individually or in groups of 2. Instruct them not to give the answer if they solve it before time is up.

	<ol style="list-style-type: none"> 3. Monitor and guide students to the solution. 4. After 10-15 minutes, discuss each puzzle, its solution, and the logic reasoning students used to solve it. Call on students at random or have them volunteer to explain their problem solving strategies.
<p>Activity</p>	<p>Geodesic Dome</p> <ol style="list-style-type: none"> 1. Pass out the MESA Notebook handout. Tell them that they will be completing this handout for each MESA activity. Tell them you will guide them through the handout today. 2. Show the students images of some geodesic domes. 3. Ask them to point out similarities. Write these on the board. 4. Ask them to point out differences. Write these on the board. 5. Guide students to identify the types of shapes used in geodesic dome design, specifically, triangles. 6. Write the term 'Geodesic Dome' on the board. Instruct them to write it in the 'key term' section of the MESA Notebook Handout. 7. Ask one student to find the definition in a dictionary and read it aloud. Write this definition on the board but instruct them not to write it on their handout. Simplify the definition into grade appropriate terminology using the images as teaching tools. Students will create a communal oral definition, write this on the board, and have them copy this into their handout. <div style="border: 1px solid black; padding: 5px; margin: 10px 0;"> <p><i>Example of a Dictionary Definition: A domed or vaulted structure of lightweight straight elements that form interlocking polygons.</i> <i>Example of Student Definition: A structure made of connected polygons.</i></p> </div> <ol style="list-style-type: none"> 8. Write the term 'polygon' on the board and have them follow the same procedure as above. When they come to writing their own definition, one suggestion is to have them draw types of polygons next to the definition instead of using vocabulary. <div style="border: 1px solid black; padding: 5px; margin: 10px 0;"> <p><i>Example of a Dictionary Definition: A closed plane figure bounded by 3 or more line segments.</i> <i>Student Definition: drawn polygon shapes</i></p> </div> <ol style="list-style-type: none"> 9. Write the term 'triangle' on the board and follow the same steps as for 'polygon'. They will draw the definition on the handout. 10. Show students a toothpick square. Ask them to identify what makes it a square. Discuss. 11. Ask students to point out where they think the weakest area/point of the square is. Most students will point to the joint area at the marshmallows. 12. Show the students a toothpick triangle. Ask them to identify what makes it a triangle. Discuss. 13. Ask students to point out where they think the weakest area/point of the triangle is. Most students will point to the joint area at the marshmallows. 14. Hold up both the toothpick square and the toothpick triangle. Point out obvious shape differences. 15. Ask, "Which of these two toothpick structures is more stable or stronger?" Solicit answers, write them on the board, and discuss. <div style="border: 1px solid black; padding: 5px; margin: 10px 0;"> <p><i>A dome must support its own dead load as well as the live load of wind, rain, snow, or ice. The geodesic dome's strength is due to the fact that triangles are very stable shapes. It is difficult to distort a triangle; compression at one joint is balanced by tension along the opposite side. The geodesic dome's design distributes loads over all the different triangles that comprise it.</i></p> </div> <ol style="list-style-type: none"> 16. Have one student come up to apply pressure to both toothpick structures. The square toothpick structure should collapse easily. You may also choose to do this part of the demonstration yourself to ensure it does.

	<ol style="list-style-type: none"> 17. Ask students, "Why is the triangle toothpick structure more stable?" Solicit answers and discuss. 18. Put the following terms on the board: 'compression' and 'tension' 19. Use the demonstration to help the students define these terms or use the dictionary as a starting point and the students can come up with their own definition again. Have students write the definition on their handout. 20. Show students pictures of geodesic domes again and ask them to describe how they would build one using toothpicks and marshmallows. Point to the toothpick triangle as a start off point. Discuss and draw on the board or model for them by adding to the triangle. 21. Tell students that they will be engineering and constructing a geodesic dome using the concepts they just learned. 22. Pass out supplies to each group. 23. Tell students to write what materials they are using under the 'Materials Used' section of their MESA Notebook handout. 24. Students will begin activity. 25. Monitor student progress. Check to make sure the base of the geodesic dome is reasonable. Some may try to make a very large base and not complete their dome in the remaining time. 26. As groups finish, instruct them to begin the 'Procedure' section of the MESA Notebook handout. They will write down all the steps they took to build their geodesic dome. 27. Allow time for clean up.
Closure	<ol style="list-style-type: none"> 1. Put pressure on top of each groups dome with books to check the strength and stability. Use one groups dome as a class model. 2. Ask students to describe how the whole structural design makes it strong. Discuss. Mention how the dome design gives even weight distribution and briefly explain what weight distribution means by going back to the book support model. 3. Have student groups hold up and demonstrate their constructed domes. 4. Each group will describe what difficulties they had in constructing their domes. 5. Point to the MESA Notebook Handout. 6. Instruct students to complete the 'Procedure' section if they did not complete it. 7. Write the following question on the board: 'What makes a geodesic dome strong?' Instruct students to answer this question on the 'Conclusion' section of the MESA Notebook handout. 8. Point out the back of the handout. It is up to you for them to draw a picture of their completed dome before the next meeting. They can label it pointing out joints, tension, and compression. <p><i>*Note: Students may complete the 'Procedure' and 'Conclusion' section of the MESA Notebook at home before the next MESA meeting if time is an issue.</i></p> <p>MESA Calendar</p> <ol style="list-style-type: none"> 1. Pass out a MESA calendar for the year or show them on an overhead. 2. Point out all the dates that involve students and give them a brief explanation of what will happen at each event. 3. When discussing Southern Regionals and MESA Day, emphasize that students will be engineering and constructing projects just like the geodesic dome in competition. 4. Ask for questions and discuss.
Informal Assessment	<ul style="list-style-type: none"> • Monitor students to check for understanding • Monitor students to check for participation
Formal Assessment	<ul style="list-style-type: none"> • Completed Geodesic Dome • Completed MESA Notebook Handout (They may complete this before the next MESA meeting)
Trouble Shooting	<ul style="list-style-type: none"> • Keep an eye on the time. Don't linger too long over a single component or you will run out of time. • Have additional supplies ready for groups that work quickly. They can add to the base of their dome.

	<ul style="list-style-type: none"> • Make sure all students participate in clean up. 						
<p>SEI Strategies Used</p> <table border="0" style="width: 100%;"> <tr> <td style="vertical-align: top; width: 33%;"> <p>Preparation</p> <ul style="list-style-type: none"> <input checked="" type="checkbox"/> Adaptation of Content <input type="checkbox"/> Links to Background <input type="checkbox"/> Links to Past Learning <input checked="" type="checkbox"/> Strategies incorporated </td> <td style="vertical-align: top; width: 33%;"> <p>Scaffolding</p> <ul style="list-style-type: none"> <input checked="" type="checkbox"/> Modeling <input checked="" type="checkbox"/> Guided practice <input type="checkbox"/> Independent practice <input checked="" type="checkbox"/> Comprehensible input </td> <td style="vertical-align: top; width: 33%;"> <p>Grouping Options</p> <ul style="list-style-type: none"> <input type="checkbox"/> Whole class <input checked="" type="checkbox"/> Small groups <input type="checkbox"/> Partners <input type="checkbox"/> Independent </td> </tr> <tr> <td style="vertical-align: top;"> <p>Integration of Processes</p> <ul style="list-style-type: none"> <input checked="" type="checkbox"/> Reading <input checked="" type="checkbox"/> Writing <input checked="" type="checkbox"/> Speaking <input checked="" type="checkbox"/> Listening </td> <td style="vertical-align: top;"> <p>Application</p> <ul style="list-style-type: none"> <input checked="" type="checkbox"/> Hands-on <input checked="" type="checkbox"/> Meaningful <input checked="" type="checkbox"/> Linked to objectives <input checked="" type="checkbox"/> Promotes engagement </td> <td style="vertical-align: top;"> <p>Assessment</p> <ul style="list-style-type: none"> <input type="checkbox"/> Individual <input checked="" type="checkbox"/> Group <input checked="" type="checkbox"/> Written <input checked="" type="checkbox"/> Oral </td> </tr> </table>		<p>Preparation</p> <ul style="list-style-type: none"> <input checked="" type="checkbox"/> Adaptation of Content <input type="checkbox"/> Links to Background <input type="checkbox"/> Links to Past Learning <input checked="" type="checkbox"/> Strategies incorporated 	<p>Scaffolding</p> <ul style="list-style-type: none"> <input checked="" type="checkbox"/> Modeling <input checked="" type="checkbox"/> Guided practice <input type="checkbox"/> Independent practice <input checked="" type="checkbox"/> Comprehensible input 	<p>Grouping Options</p> <ul style="list-style-type: none"> <input type="checkbox"/> Whole class <input checked="" type="checkbox"/> Small groups <input type="checkbox"/> Partners <input type="checkbox"/> Independent 	<p>Integration of Processes</p> <ul style="list-style-type: none"> <input checked="" type="checkbox"/> Reading <input checked="" type="checkbox"/> Writing <input checked="" type="checkbox"/> Speaking <input checked="" type="checkbox"/> Listening 	<p>Application</p> <ul style="list-style-type: none"> <input checked="" type="checkbox"/> Hands-on <input checked="" type="checkbox"/> Meaningful <input checked="" type="checkbox"/> Linked to objectives <input checked="" type="checkbox"/> Promotes engagement 	<p>Assessment</p> <ul style="list-style-type: none"> <input type="checkbox"/> Individual <input checked="" type="checkbox"/> Group <input checked="" type="checkbox"/> Written <input checked="" type="checkbox"/> Oral
<p>Preparation</p> <ul style="list-style-type: none"> <input checked="" type="checkbox"/> Adaptation of Content <input type="checkbox"/> Links to Background <input type="checkbox"/> Links to Past Learning <input checked="" type="checkbox"/> Strategies incorporated 	<p>Scaffolding</p> <ul style="list-style-type: none"> <input checked="" type="checkbox"/> Modeling <input checked="" type="checkbox"/> Guided practice <input type="checkbox"/> Independent practice <input checked="" type="checkbox"/> Comprehensible input 	<p>Grouping Options</p> <ul style="list-style-type: none"> <input type="checkbox"/> Whole class <input checked="" type="checkbox"/> Small groups <input type="checkbox"/> Partners <input type="checkbox"/> Independent 					
<p>Integration of Processes</p> <ul style="list-style-type: none"> <input checked="" type="checkbox"/> Reading <input checked="" type="checkbox"/> Writing <input checked="" type="checkbox"/> Speaking <input checked="" type="checkbox"/> Listening 	<p>Application</p> <ul style="list-style-type: none"> <input checked="" type="checkbox"/> Hands-on <input checked="" type="checkbox"/> Meaningful <input checked="" type="checkbox"/> Linked to objectives <input checked="" type="checkbox"/> Promotes engagement 	<p>Assessment</p> <ul style="list-style-type: none"> <input type="checkbox"/> Individual <input checked="" type="checkbox"/> Group <input checked="" type="checkbox"/> Written <input checked="" type="checkbox"/> Oral 					
<p>Arizona Math Standards Addressed</p>	<ul style="list-style-type: none"> • S5C1: TSW use reasoning to solve mathematical problems in contextual situations to solve a simple logic problem from given information 						
<p>Arizona Science Standards Addressed</p>	<ul style="list-style-type: none"> • S1C1: TSW formulate predictions and questions based on observations. • S1C2: TSW design a controlled investigation and keep a record of their observations, notes, and sketches. • S1C4: TSW communicate the results of their investigation and create a list of instructions that others can follow. • S2C2: TSW understand how science is a process for generating knowledge and apply scientific processes to problem solving situations. 						

Birthday Cake

The birthday cake on the picture must be cut into eight equally sized pieces. However, you are allowed to make only 3 straight cuts.



The Question: How can the be cut into eight pieces with only 3 straight cuts.

Hans & Gerrie

Hans is standing behind Gerrie and at the same time Gerrie is standing behind Hans.

The Question: How is this possible?

Birthday Cake

The birthday cake on the picture must be cut into eight equally sized pieces. However, you are allowed to make only 3 straight cuts.

The Question: How can the be cut into eight pieces with only 3 straight cuts. This is how the cake could be cut (seen from above), if we would prefer to have both top and bottom parts in each piece:

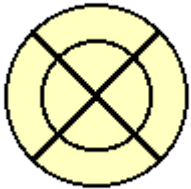

Note however that this is not a real solution, since it has non-straight cuts. In this way, we could think of many other 'solutions', like:

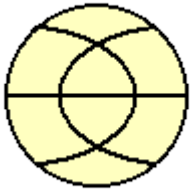

Finally, an alternative solution that requires some rearrangement of the pieces after the first two cuts, is the following: like before, make the first two cuts cross-wise, then arrange all four pieces in a row, and make the third straight cut like this:

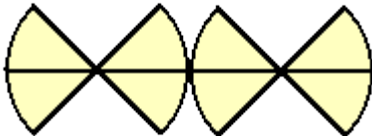

Hans & Gerrie

Hans is standing behind Gerrie and at the same time Gerrie is standing behind Hans.

The Question: How is this possible?

Hans and Gerrie are standing with their backs towards each other!



Lesson Activity

Week	3
Suggested Sequence of Activities	<ul style="list-style-type: none"> • Math Problem: Perimeter Matters (10-15 minutes) • Float Your Boat (20-25 minutes) • MESA Student Policies and Procedures (30-35 minutes)
Duration	60-75 minutes
Age Level	Middle School
Essential Question	How does the modification of clay affect whether it floats in water?
Learning Objectives	<p>Math Problem</p> <ul style="list-style-type: none"> • TSW solve a multi-step word problem using age-appropriate problem solving strategies • TSW apply their previous knowledge of measurement, computation, and geometric properties to find the perimeter of a given problem • TSW write their answer with proper unit of measure <p>Float Your Boat</p> <ul style="list-style-type: none"> • TSW compare the floatation abilities of different clay shapes • TSW explain why modifying the shape of modeling clay allows it to float • TSW manipulate the shape of their clay so that it does float in water • TSW hypothesize the reason for a structure's ability to float and apply their reasoning to their own clay model • TSW deduce that more surface area allows the water molecules to push against the surface of the clay that allows it to float • TSW deduce that clay spread over more surface area displaces more water that allows it to float • TSW communicate the results of the activity to their peers
Other Objectives	<ul style="list-style-type: none"> • TSW develop a working plan with their group to develop a cooperative environment • TSW communicate with their group by contributing their vocal input
Key Terms	<ul style="list-style-type: none"> • Hypothesis • Modify • Surface area • Molecules and Water Molecules (optional)
Materials Needed	<p>Math Problem:</p> <ul style="list-style-type: none"> • Handout: Perimeter Matters <p>Float Your Boat:</p> <ul style="list-style-type: none"> • Chunk of modeling clay for demonstration • Large bowl or tub of water • Marbles • Paper Towel <p>Per Team (2 students)</p> <ul style="list-style-type: none"> • Modeling Clay- 1" square or 50g • MESA Notebook Handout <p>MESA Policies and Procedures:</p> <ul style="list-style-type: none"> • Student Policies and Procedures Handout
Lead In	<p>Math Problem:</p> <ol style="list-style-type: none"> 5. Pass math problem out to students as they arrive for MESA meeting. Remind them to sign in on attendance sheet. 6. Inform students that they may work individually or in groups of 2. Instruct them not to give the answer if they solve it before time is up. 7. Monitor and guide students to the solution. 8. After 10-15 minutes, have one student model each problem on the board to

	<p>explain how they arrived at their answer. Discuss alternate methods of problem solving with students.</p> <p>9. Collect MESA Notebook handout from previous meeting and discuss. Students may wish to share their sketches.</p>
<p>Activity</p>	<p>Float Your Boat:</p> <ol style="list-style-type: none"> 1. Pass out MESA Notebook handout. Quickly review how to complete handout. 2. Direct student's attention to teacher demonstration. 3. Hold up a ball of modeling clay. 4. Ask, "When I drop this in the water, who thinks it will float? (pause and wait for responses) Who thinks it will sink? (Pause and wait for responses) 5. Ask students to defend and explain their predictions. 6. Write the term 'hypothesis' on the board and Instruct students to write it in the 'key term' section of their MESA Notebook handout. 7. Ask, "What is a hypothesis?" Most students will know, guide them to a class definition and put it on the board. Have students write the class definition on their handout. 8. Apply the definition to the hypothesis they just made about whether or not the ball of clay will float. 9. Drop clay into the water. (Clay should sink) 10. Ask students, "What can I do to this clay to try to make it float?" Solicit answers and discuss. Students will make the same suggestions such as flatten it out, make it thin, make sure there are walls on the edges so water doesn't get in... 11. Write the term 'modify' on the board and instruct students to write the term in the 'key term' section of their handout. Ask one student to look up the definition in a dictionary. The general definition is 'to change'. This simple definition can be used as the student definition. 12. Now ask, "How can I modify this clay to try to make it float?" Students will make the same suggestions such as flatten it out, make it thin, make sure there are walls on the edges so water doesn't get in... 13. Point out that 'to modify' something is 'to change it' so it works better. 14. Use student suggestions to guide them to a communal understanding that the more spread out the clay is, the better chance it has of floating. 15. Write the term 'surface area' on the board. Ask students to come up with a definition of the term on their own using word recognition strategies. Guide students by using other objects in the room that have large surface areas. Many will already know what surface area is. Write a communal definition on the board and have them copy it on their handout. 16. Review how their suggestions of spreading the clay out will give the clay a better chance of floating because of the increase in surface area. 17. Ask, "When my clay boat floats, what is keeping it from sinking?" Student suggestions will vary. You can help them by asking, "To keep something from going down, something has to push it up. What could be pushing up against my boat to keep it from going down?" Guide students so they understand that the water is pushing up against the boat. 18. Review how surface area spreads the clay out, now guide students to understand that the more surface area there it, the more areas there are for water to push up against. You may introduce water molecules here. 19. Tell students that they are to use the concepts of 'modifying' and 'surface area' to design and mold a chunk of clay into a boat that can float. Their boat has to float and hold a minimum of 5 marbles. 20. Pass out the clay and allow students 5 minutes to come up with a boat. <i>Remind students to write the materials in the 'materials used' section of the MESA Notebook.</i> 21. Have them test it. 22. Give them another 5 minutes to modify their design. 23. Test all the boats.
<p>Closure</p>	<ol style="list-style-type: none"> 1. Ask students to hold up their boats and explain how their team arrived at the final design. 2. Ask students to describe any problems they had in designing and constructing

	<p>their boat.</p> <ol style="list-style-type: none"> 3. Ask students to describe what they would change to make their boat better if they had more time. 4. Instruct students to complete the 'procedure' section of the MESA Notebook. It should be a sequential description of their team's design and construction of their boat. 5. Instruct students to answer the following question in the 'conclusion' section of the MESA Notebook: <i>How does the modification of clay affect whether it floats or not?</i> <p><i>*Note: Students may complete the 'Procedure' and 'Conclusion' section of the Engineer's notebook at home before the next MESA meeting if time is an issue.</i></p> <p>MESA Student Policies and Procedures</p> <ol style="list-style-type: none"> 1. Review MESA Mission and MESA Calendar. Answer questions they may have. 2. Pass out handouts that give Student Policies and Procedures Overview. 3. Go over what is expected of students and your role in helping them successfully achieve these expectations. 4. Discuss and answer questions. 						
Informal Assessment	<ul style="list-style-type: none"> • Monitor students to check for understanding • Monitor students to check for participation • Student oral presentation explaining their team's procedure 						
Formal Assessment	<ul style="list-style-type: none"> • Completed Clay Boat • Completed MESA Notebook Handout (They may complete this before the next MESA meeting) 						
Trouble Shooting	<ul style="list-style-type: none"> • Keep an eye on the time. Don't linger too long over a single component or you will run out of time. • Make sure all students participate in clean up. • Before lesson, fill bowl/tub with water. • Keep an eye on the marbles. 						
<p>SEI Strategies Used</p> <table border="0" style="width: 100%;"> <tr> <td style="vertical-align: top; width: 33%;"> <p>Preparation</p> <input type="checkbox"/> Adaptation of Content <input type="checkbox"/> Links to Background <input type="checkbox"/> Links to Past Learning <input checked="" type="checkbox"/> Strategies incorporated </td> <td style="vertical-align: top; width: 33%;"> <p>Scaffolding</p> <input type="checkbox"/> Modeling <input checked="" type="checkbox"/> Guided practice <input type="checkbox"/> Independent practice <input checked="" type="checkbox"/> Comprehensible input </td> <td style="vertical-align: top; width: 33%;"> <p>Grouping Options</p> <input type="checkbox"/> Whole class <input type="checkbox"/> Small groups <input checked="" type="checkbox"/> Partners <input type="checkbox"/> Independent </td> </tr> <tr> <td style="vertical-align: top;"> <p>Integration of Processes</p> <input type="checkbox"/> Reading <input checked="" type="checkbox"/> Writing <input checked="" type="checkbox"/> Speaking <input checked="" type="checkbox"/> Listening </td> <td style="vertical-align: top;"> <p>Application</p> <input checked="" type="checkbox"/> Hands-on <input checked="" type="checkbox"/> Meaningful <input checked="" type="checkbox"/> Linked to objectives <input checked="" type="checkbox"/> Promotes engagement </td> <td style="vertical-align: top;"> <p>Assessment</p> <input type="checkbox"/> Individual <input checked="" type="checkbox"/> Group <input checked="" type="checkbox"/> Written <input checked="" type="checkbox"/> Oral </td> </tr> </table>		<p>Preparation</p> <input type="checkbox"/> Adaptation of Content <input type="checkbox"/> Links to Background <input type="checkbox"/> Links to Past Learning <input checked="" type="checkbox"/> Strategies incorporated	<p>Scaffolding</p> <input type="checkbox"/> Modeling <input checked="" type="checkbox"/> Guided practice <input type="checkbox"/> Independent practice <input checked="" type="checkbox"/> Comprehensible input	<p>Grouping Options</p> <input type="checkbox"/> Whole class <input type="checkbox"/> Small groups <input checked="" type="checkbox"/> Partners <input type="checkbox"/> Independent	<p>Integration of Processes</p> <input type="checkbox"/> Reading <input checked="" type="checkbox"/> Writing <input checked="" type="checkbox"/> Speaking <input checked="" type="checkbox"/> Listening	<p>Application</p> <input checked="" type="checkbox"/> Hands-on <input checked="" type="checkbox"/> Meaningful <input checked="" type="checkbox"/> Linked to objectives <input checked="" type="checkbox"/> Promotes engagement	<p>Assessment</p> <input type="checkbox"/> Individual <input checked="" type="checkbox"/> Group <input checked="" type="checkbox"/> Written <input checked="" type="checkbox"/> Oral
<p>Preparation</p> <input type="checkbox"/> Adaptation of Content <input type="checkbox"/> Links to Background <input type="checkbox"/> Links to Past Learning <input checked="" type="checkbox"/> Strategies incorporated	<p>Scaffolding</p> <input type="checkbox"/> Modeling <input checked="" type="checkbox"/> Guided practice <input type="checkbox"/> Independent practice <input checked="" type="checkbox"/> Comprehensible input	<p>Grouping Options</p> <input type="checkbox"/> Whole class <input type="checkbox"/> Small groups <input checked="" type="checkbox"/> Partners <input type="checkbox"/> Independent					
<p>Integration of Processes</p> <input type="checkbox"/> Reading <input checked="" type="checkbox"/> Writing <input checked="" type="checkbox"/> Speaking <input checked="" type="checkbox"/> Listening	<p>Application</p> <input checked="" type="checkbox"/> Hands-on <input checked="" type="checkbox"/> Meaningful <input checked="" type="checkbox"/> Linked to objectives <input checked="" type="checkbox"/> Promotes engagement	<p>Assessment</p> <input type="checkbox"/> Individual <input checked="" type="checkbox"/> Group <input checked="" type="checkbox"/> Written <input checked="" type="checkbox"/> Oral					
Arizona Math Standards Addressed	<ul style="list-style-type: none"> • S1C2: TSW understand and apply numerical operations and their relationship to one another by solving word problems using grade-level appropriate operations and numbers. • S4C4: TSW understand and apply appropriate units of measure, measurement techniques, and formulas to determine measurement. Specifically, to distinguish between perimeter and area in given contextual situation. 						
Arizona Science Standards Addressed	<ul style="list-style-type: none"> • S1C1: TSW formulate predictions and questions based on observations. • S1C2: TSW design a controlled investigation and keep a record of their observations, notes, and sketches. • S1C4: TSW communicate the results of their investigation and create a list of instructions that others can follow. • S2C2: TSW understand how science is a process for generating knowledge and apply scientific processes to problem solving situations. 						



Lesson Activity

Week	4
Suggested Sequence of Activities	<ul style="list-style-type: none"> • Keep a Cube (15-20 minutes for activity) • Math Problem: Designing an Inlaid Table (20-25 minutes) • MESA Student AIF Data (10-15 minutes) • Keep a Cube Follow Up (15-20 minutes)
Duration	60-80 minutes
Age Level	Middle School
Essential Question	How does insulating an object keep it from melting quickly?
Learning Objectives	<p>Keep a Cube</p> <ul style="list-style-type: none"> • TSW discuss how objects are kept from getting hot • TSW apply their understanding of heat to develop an engineering plan to keep an ice cube from melting using given materials • TSW design their ice keeper to maximize the efficiency of all materials • TSW define 'insulation' and apply this concept to their design • TSW describe how different variables can affect the quality of their design <p>Math Problem</p> <ul style="list-style-type: none"> • TSW identify patterns and apply pattern recognition to solve grade level appropriate pattern problems • TSW manipulate various pattern combinations to solve a mathematical pattern puzzle
Other Objectives	<ul style="list-style-type: none"> • TSW communicate the results of their investigation to their peers • TSW listen as their peers discuss the design of their investigation • TSW write down the procedure they used to design their project
Key Terms	<ul style="list-style-type: none"> • Insulation • Variable
Materials Needed	<p>Keep a Cube</p> <p>Per Group</p> <ul style="list-style-type: none"> • Ice Cube (for demonstration and to keep 'time') <p>Per Student (REMEMBER: All students should get the <u>same amount</u> of materials to ensure that the design process is objective)</p> <ul style="list-style-type: none"> • 1 ice cube • Wax paper • Masking tape • Newspaper • Aluminum foil • Rubber band(s) • Paper plate • Other assorted materials that the teacher feels will add to the design element <i>examples include cardboard, pipe cleaners, straws, etc...</i> • MESA Notebook handout <p>Math Problem</p> <p>Per student</p> <ul style="list-style-type: none"> • Designing an Inlaid Table Top handout • Table Top Grid handout • Construction paper in the following colors: red, blue, green, yellow, and brown • Scissors
Lead In	<ol style="list-style-type: none"> 1. Remind students to sign in on attendance sheet. 2. Have students take out their MESA Diary handout from the previous week. 3. Discuss conclusion question and student responses. 4. Tell students that they will be doing the MESA activity before the Math problem this week. 5. Pass out new MESA Notebook handout. 6. Write the term 'insulation' on the board. Instruct students to write term on

	<p>their MESA Notebook handout.</p> <ol style="list-style-type: none"> 7. Ask students to give examples of types of insulation. Ex. Human fat, house insulation, jackets, etc... 8. Guide students to define insulation in their own words. Ex. Insulation is something that prevents heat from escaping. 9. Have students write this definition down on their MESA Notebook handout. Tell them to add examples of insulation next to the definition. 10. Hold up one ice cube. Ask students to describe what will happen if you leave it on a desk. Student responses will be that it will melt. 11. Ask students, "How can we insulate the ice cube so it doesn't melt?" Get various answers and discuss. Review what insulate means and how it applies to keeping the ice cube from melting.
Activity	<ol style="list-style-type: none"> 1. Tell students that they will be constructing insulation for an ice cube. 2. Hold up the materials that each student will be getting. Tell them that they are all getting the same amount of materials and that they can use it any way they want. They do not have to use all of their materials, but they can't give away their unused materials, either. 3. Instruct students to write the materials under the 'materials used' section of their MESA Notebook handout. 4. Pass out the materials to students. 5. Tell them they have 10 minutes to insulate their ice. Show them a separate ice cube and put it on the table in the front. Tell them when this ice cube melts all the way, all students will unwrap their insulated ice cube to compare and see whose insulation worked the best. 6. After 10 minutes, have students keep their insulated ice cube at their table/desk. 7. Instruct students to complete the 'procedure' section of their MESA Notebook handout. <p>Math Problem</p> <ol style="list-style-type: none"> 1. Pass out Design an Inlaid Table Top handout. 2. Call on a student to read the instructions and have students tell you in their own words what they will be doing. 3. Tell students that they will be using the Table Top handout for testing their pattern designs. 4. Instruct students to get scissors and construction paper to cut 5 pieces of each color. 5. Model for them how they can use the colored paper manipulatives to solve the problem. 6. When the students have one pattern solved, tell them to write the pattern on their Design an Inlaid Table Top handout. 7. Allow them 15-20 minutes to solve 2 possible patterns. 8. Monitor their progress. 9. When time is up, have students share their pattern with each other. There will be different pattern possibilities. Have students check other student work. <p>Student AIF</p> <ol style="list-style-type: none"> 1. Pass out AIF packet. 2. Discuss and clarify the MESA family agreement component. Answer any questions. 3. Encourage students to discuss the parent responsibilities with their family when they get home. 4. Emphasize the importance and conditions of the form. The student needs to understand the meaning of completing the AIF form and how it will affect them. Items to address: access to their school records for data development, usage of their image in pictures for MESA promotion 5. Guide students through the completion of the AIF form. Remind them to write legibly. 6. Complete student portion of the form and have them take it home for parent completion.
Closure	<p>Keep A Cube Follow Up</p> <ol style="list-style-type: none"> 1. Have students unwrap their cube.

	<ol style="list-style-type: none"> 2. Compare student ice cubes to see which student has the most of their ice cube left. Let this student describe their design and explain how they developed it. 3. Compare and contrast various design components. 4. Tell students to answer the following question in the 'conclusion' section of their MESA Notebook handout: <i>How does insulating an object keep it from melting quickly?</i> Tell them to make references to their design. 5. Clean up. 						
Informal Assessment	<ul style="list-style-type: none"> • Monitor students to check for engagement • Monitor students to check for understanding 						
Formal Assessment	<ul style="list-style-type: none"> • Completed insulated ice cube • Completed MESA Notebook handout • Completed Design an Inlaid Table handout 						
Trouble Shooting	<ul style="list-style-type: none"> • After students insulate their ice cube, you will begin the math problem. <u>Check the melting ice cube on the desk continually. The student insulated ice cubes must be checked as soon as the desk ice cube melts.</u> • Keep an eye on the time. Don't linger too long over a single component or you will run out of time. • Make sure all students participate in clean up. • Have all materials ready before students come, or you will waste a lot of time. For example, have the sheets of foil already cut and ready to pass out. Have the wax paper already cut and ready to pass out. 						
SEI Strategies Used							
<table style="width: 100%; border: none;"> <tr> <td style="vertical-align: top; width: 33%;"> Preparation <input type="checkbox"/> Adaptation of Content <input type="checkbox"/> Links to Background <input type="checkbox"/> Links to Past Learning <input checked="" type="checkbox"/> Strategies incorporated </td> <td style="vertical-align: top; width: 33%;"> Scaffolding <input checked="" type="checkbox"/> Modeling <input type="checkbox"/> Guided practice <input type="checkbox"/> Independent practice <input checked="" type="checkbox"/> Comprehensible input </td> <td style="vertical-align: top; width: 33%;"> Grouping Options <input type="checkbox"/> Whole class <input type="checkbox"/> Small groups <input type="checkbox"/> Partners <input checked="" type="checkbox"/> Independent </td> </tr> <tr> <td style="vertical-align: top;"> Integration of Processes <input checked="" type="checkbox"/> Reading <input checked="" type="checkbox"/> Writing <input checked="" type="checkbox"/> Speaking <input checked="" type="checkbox"/> Listening </td> <td style="vertical-align: top;"> Application <input checked="" type="checkbox"/> Hands-on <input checked="" type="checkbox"/> Meaningful <input checked="" type="checkbox"/> Linked to objectives <input type="checkbox"/> Promotes engagement </td> <td style="vertical-align: top;"> Assessment <input checked="" type="checkbox"/> Individual <input type="checkbox"/> Group <input type="checkbox"/> Written <input type="checkbox"/> Oral </td> </tr> </table>		Preparation <input type="checkbox"/> Adaptation of Content <input type="checkbox"/> Links to Background <input type="checkbox"/> Links to Past Learning <input checked="" type="checkbox"/> Strategies incorporated	Scaffolding <input checked="" type="checkbox"/> Modeling <input type="checkbox"/> Guided practice <input type="checkbox"/> Independent practice <input checked="" type="checkbox"/> Comprehensible input	Grouping Options <input type="checkbox"/> Whole class <input type="checkbox"/> Small groups <input type="checkbox"/> Partners <input checked="" type="checkbox"/> Independent	Integration of Processes <input checked="" type="checkbox"/> Reading <input checked="" type="checkbox"/> Writing <input checked="" type="checkbox"/> Speaking <input checked="" type="checkbox"/> Listening	Application <input checked="" type="checkbox"/> Hands-on <input checked="" type="checkbox"/> Meaningful <input checked="" type="checkbox"/> Linked to objectives <input type="checkbox"/> Promotes engagement	Assessment <input checked="" type="checkbox"/> Individual <input type="checkbox"/> Group <input type="checkbox"/> Written <input type="checkbox"/> Oral
Preparation <input type="checkbox"/> Adaptation of Content <input type="checkbox"/> Links to Background <input type="checkbox"/> Links to Past Learning <input checked="" type="checkbox"/> Strategies incorporated	Scaffolding <input checked="" type="checkbox"/> Modeling <input type="checkbox"/> Guided practice <input type="checkbox"/> Independent practice <input checked="" type="checkbox"/> Comprehensible input	Grouping Options <input type="checkbox"/> Whole class <input type="checkbox"/> Small groups <input type="checkbox"/> Partners <input checked="" type="checkbox"/> Independent					
Integration of Processes <input checked="" type="checkbox"/> Reading <input checked="" type="checkbox"/> Writing <input checked="" type="checkbox"/> Speaking <input checked="" type="checkbox"/> Listening	Application <input checked="" type="checkbox"/> Hands-on <input checked="" type="checkbox"/> Meaningful <input checked="" type="checkbox"/> Linked to objectives <input type="checkbox"/> Promotes engagement	Assessment <input checked="" type="checkbox"/> Individual <input type="checkbox"/> Group <input type="checkbox"/> Written <input type="checkbox"/> Oral					
Arizona Math Standards Addressed	<ul style="list-style-type: none"> • S3C1: TSW identify patterns and apply pattern recognition to reason mathematically. 						
Arizona Science Standards Addressed	<ul style="list-style-type: none"> • S1C2: TSW design and conduct a controlled investigation demonstrating safe behavior and appropriate procedures and keeping a record of their observations, notes and sketches. • S1C4: TSW communicate the results of their investigation and create a list of instructions that others can follow in carrying out a procedure. • S5C1: TSW understand the physical properties of matter. 						

Designing an Inlaid Table

Student Worksheet

Red	Blue	Green	Yellow	Brown

Students:

Use this worksheet to manipulate the 5 squares of red, blue, green, yellow, and brown construction paper to help you solve the puzzle. When you think you have a pattern, raise your hand and your advisor will check it for you. Then, write the color patterns on your worksheet.

Week	5
Name of Activity	What's My Style
Duration	60 - 80 minutes
Age Level	Middle School
Essential Question	Which learning style is your strongest?
Learning Objectives	<p>The Learning Brain (activity 108 in Cooperative Games booklet)</p> <ul style="list-style-type: none"> • TSW will gain an understanding about the creation of learning pathways in their brain • TSW will gain an understanding about what positively and negatively affects the creating of learning pathways <p>What's My Style</p> <ul style="list-style-type: none"> • TSW will gain an understanding of different learning styles • TSW will identify what learning style(s) suit them best • TSW will apply their understanding of learning styles to communicate with others • TSW identify study strategies that pertain to each learning style
Other Objectives	<ul style="list-style-type: none"> • TSW will track, analyze, and discuss how stress affects learning • TSW will discuss different stresses in their lives that affect learning • TSW will discuss how to improve their learning environment • TSW will identify with others and develop a better understanding of their peers
Key Terms	<ul style="list-style-type: none"> • Learning Pathways • Neurons • Synaptic Connections • Hormones • Cortinoids • Learning Style
Materials Needed	<p>The Learning Brain</p> <ul style="list-style-type: none"> • Small balls or props (1/3 the number of the group) • Balloons (1/2 the number of the group) • Timer <p>What's My Style</p> <ul style="list-style-type: none"> • Visual Test - page with 15 graphics for visual test • Auditory Test - list of 15 items for auditory test • Kinesthetic Test - 10 small objects • Graphic for communication activity <p>Per student</p> <ul style="list-style-type: none"> • Learning Styles inventory • Traits of Learning Styles • Study Strategies for the Three Learning Styles • 20 Memory Techniques for More Productive Study Habits • Learning How to Learn
Lead In	<ol style="list-style-type: none"> 1. Remind students to sign in on attendance sheet 2. Have students take out their MESA Notebook from the previous week 3. Discuss conclusion question and student responses 4. Pass out new MESA Notebook 5. Tell students that they will be learning about their brain and learning 6. Write the terms "neuron, synaptic connection, hormone, Cortinoids" on the board. Instruct students to write terms on their MESA Notebook 7. Ask group if anyone knows what a neuron is and what it does 8. Discuss and explain that neurons connect with each other and relay messages via synaptic connections creating learning pathways

<p>Activity</p>	<p>The Learning Brain</p> <ol style="list-style-type: none"> 1. Tell the students that today they will be neurons and ask them to stand up 2. Trial one - <ul style="list-style-type: none"> • Explain that they will have 20-30 seconds to relay messages to other neurons via a handshake, and that when they shake hands they must also carefully look into the eyes of the other person • Explain that they will need to keep track of how many messages they pass/receive • Run trial one • Have students write down the number of messages in their MESA Notebook under procedure 3. Trial two - <ul style="list-style-type: none"> • Explain that the brain is bathed by multiple chemicals and hormones that make learning easier or harder (<i>See Cooperative Games Booklet for more information</i>). • Explain that the small props will represent a good balance of chemicals and that when you have them in your hand you, a neuron, will be very engaged, energized and happy • Explain that we will again have 20-30 seconds to relay messages but that a few props, "chemicals", will be introduced and passed along with the handshake • Explain that in addition to the number of messages passed/received they will need to have a rough idea of how many times they had the "chemicals" • Run trial two • Have students write down the number of messages and number of messages with "chemicals" in their MESA notebook 4. Trial three - <ul style="list-style-type: none"> • Explain that the brain can also be bathed with too many stress chemicals, called Cortinoids, that limit or prevent the passing of messages in learning pathways • Explain that we will again have 20-30 seconds to relay messages and good "chemicals" but that the balloons will represent Cortinoids and must be kept in the air • Explain that they will again need to track the number of messages and messages with "chemicals" they pass/receive • Run trial three • Have students write down the number of messages and messages with "chemicals" in their MESA Notebook 5. Conclusion <ul style="list-style-type: none"> • Ask student to look at their data and write down what happened over the three trials • Ask students if it was easy to shake hands when dealing with the balloons. • Ask them if they can relate this to different stresses in their lives and which ones (i.e. social, institutional, familial, stresses related to body appearance) • Ask them what this activity teaches us about creating an ideal learning environment <p>What's My Style?</p> <ol style="list-style-type: none"> 1. Pass out a second MESA Notebook handout. 2. Write the terms "learning style, auditory, visual, kinesthetic" on the board and ask the students to copy them onto their MESA Notebook 3. Ask if anyone knows what a learning style is 4. If needed, explain that a learning style is a way in which someone learns. 5. Explain that today they will learn about the three learning styles listed above 6. Ask the students to create three columns in their MESA Notebook under procedure and label them A, V, and K 7. Have the students turn their paper over and put their pencil down. 8. Visual Test <ul style="list-style-type: none"> • Show the group the Visual Test page for 20 seconds then cover
------------------------	--

- Briefly distract the students by asking them what's their first class, what is 7 x 8, or to count backwards from 10
- Have them turn their paper over and write down as many of the objects they can remember in the "V" column.
- Show them the Visual Test page again and have them count how many they had correct. They should write their answer at the bottom of the "V" column

9. Auditory Test

- Ask the student to turn their MESA Notebook over and put their pencil down
- Ask the students to close their eyes and put their heads on their desk
- Slowly read the list of words from the auditory page and then read it a second time
- Distract students
- Have them turn their paper over and write down as many of the words they can remember in the "A" column
- Repeat the list and have them count how many they had correct. They should write their answer at the bottom of the "A" Column

10. Kinesthetic Test

- Ask the students to stand and form a circle.
- Have them close their eyes and keep them closed unless they are given an object
- Hand out the ten objects to ten students
- If they have an object they can open their eyes and examine the object by seeing and touching it for 10 seconds
- When time is up call out pass and have that student pass the object to their right
- Continue until every student has examined each object, and then have the students close their eyes and remove the objects from sight
- Have the students sit down and write down the objects they can remember in the "K" column
- Bring out the objects and have the students count how many they had correct and write that number at the bottom of the "K" column

11. Inventory

- Ask the students to circle the column where they had the most correct
- Explain that each of the columns represented a learning style and that the one they circled was their strongest
- Hand out the "Learning Styles Inventory" worksheet.
- Have the students fill it out on their own
- Discuss how closely the results matched the ones from above and why there might have been differences

12. Communication Exercise

- Have the students make groups of three containing one visual, one auditory, and one kinesthetic learner. Use second strongest style to even out groups
- Have all the visual learners come to the front and look at the communication graphic for 20-25 seconds and tell them to remember it exactly
- Have them explain the graphic to the auditory learner without allowing the kinesthetic learner hear. Give them about 30 seconds
- Have the auditory learner explain the pattern to the kinesthetic learner, who will draw what is being described to them
- When finished have the kinesthetic person come to the front and show the class the class their design. Also, show everyone the original graphic
- Ask the students to discuss what caused differences between the designs and what they could have helped them do it better
- Ask them if their learning styles succeeded in helping them teach other

13. Application Exercise

- Ask the students to get into three groups according to their strongest

	<p>learning style. Use the second strongest to even out the groups</p> <ul style="list-style-type: none"> • Handout "20 Memory Techniques" and "Learning How to Learn" • Ask the groups to read through them and discuss how they can adapt this information to fit with their learning style. • Have each group present their ideas 						
Closure	<ul style="list-style-type: none"> • Handout "Traits of Learning Styles" and "Study Strategies for the Three Learning Modes" • Ask the student to review these handouts before the next meeting • Ask the students to answer the following question in the 'conclusion' section of their MESA Handbook: What changes to my learning environments (school, home) will I make to help me learn and study more efficiently 						
Informal Assessment	<ul style="list-style-type: none"> • Monitor students to check for engagement • Monitor students to check for understanding 						
Formal Assessment	<ul style="list-style-type: none"> • Completed MESA Handbook for "The Learning Brain" • Completed MESA Handbook for "What's My Style" • Completed Learning Styles Inventory worksheet 						
Trouble Shooting	<ul style="list-style-type: none"> • Make sure students are properly shaking hands during "The Learning Brain" • Make sure that balloons do not remain on floor • Keep an eye on time • Make sure students are closing eyes when needed • Make sure students are not writing before allowed • Have students assist you in passing out handouts to save time • If running out of time, have students do application exercise on their own 						
Extensions	<ul style="list-style-type: none"> • Career Exploration CPW discussing careers based on learning styles • Discussion about how learning styles in various contexts (i.e. sports, jobs) • Deeper discussion about how neurons work to translate thoughts into actions (i.e. speaking, moving) • Deeper discussion about how drugs like MAO/SSRI Inhibitors impact neurons • Discuss how students can improve their weaker learning styles • Mention "Brain Age" game for Nintendo DS which uses fun visual/audio games to "train" your brain in different learning styles. 						
SEI Strategies Used							
<table border="0"> <tr> <td> Preparation <input type="checkbox"/> Adaptation of Content <input type="checkbox"/> Links to Background <input checked="" type="checkbox"/> Links to Past Learning <input checked="" type="checkbox"/> Strategies incorporated </td> <td> Scaffolding <input type="checkbox"/> Modeling <input checked="" type="checkbox"/> Guided practice <input type="checkbox"/> Independent practice <input checked="" type="checkbox"/> Comprehensible input </td> <td> Grouping Options <input checked="" type="checkbox"/> Whole class <input checked="" type="checkbox"/> Small groups <input type="checkbox"/> Partners <input checked="" type="checkbox"/> Independent </td> </tr> <tr> <td> Integration of Processes <input checked="" type="checkbox"/> Reading <input checked="" type="checkbox"/> Writing <input checked="" type="checkbox"/> Speaking <input checked="" type="checkbox"/> Listening </td> <td> Application <input checked="" type="checkbox"/> Hands-on <input checked="" type="checkbox"/> Meaningful <input checked="" type="checkbox"/> Linked to objectives <input checked="" type="checkbox"/> Promotes engagement </td> <td> Assessment <input checked="" type="checkbox"/> Individual <input checked="" type="checkbox"/> Group <input checked="" type="checkbox"/> Written <input type="checkbox"/> Oral </td> </tr> </table>		Preparation <input type="checkbox"/> Adaptation of Content <input type="checkbox"/> Links to Background <input checked="" type="checkbox"/> Links to Past Learning <input checked="" type="checkbox"/> Strategies incorporated	Scaffolding <input type="checkbox"/> Modeling <input checked="" type="checkbox"/> Guided practice <input type="checkbox"/> Independent practice <input checked="" type="checkbox"/> Comprehensible input	Grouping Options <input checked="" type="checkbox"/> Whole class <input checked="" type="checkbox"/> Small groups <input type="checkbox"/> Partners <input checked="" type="checkbox"/> Independent	Integration of Processes <input checked="" type="checkbox"/> Reading <input checked="" type="checkbox"/> Writing <input checked="" type="checkbox"/> Speaking <input checked="" type="checkbox"/> Listening	Application <input checked="" type="checkbox"/> Hands-on <input checked="" type="checkbox"/> Meaningful <input checked="" type="checkbox"/> Linked to objectives <input checked="" type="checkbox"/> Promotes engagement	Assessment <input checked="" type="checkbox"/> Individual <input checked="" type="checkbox"/> Group <input checked="" type="checkbox"/> Written <input type="checkbox"/> Oral
Preparation <input type="checkbox"/> Adaptation of Content <input type="checkbox"/> Links to Background <input checked="" type="checkbox"/> Links to Past Learning <input checked="" type="checkbox"/> Strategies incorporated	Scaffolding <input type="checkbox"/> Modeling <input checked="" type="checkbox"/> Guided practice <input type="checkbox"/> Independent practice <input checked="" type="checkbox"/> Comprehensible input	Grouping Options <input checked="" type="checkbox"/> Whole class <input checked="" type="checkbox"/> Small groups <input type="checkbox"/> Partners <input checked="" type="checkbox"/> Independent					
Integration of Processes <input checked="" type="checkbox"/> Reading <input checked="" type="checkbox"/> Writing <input checked="" type="checkbox"/> Speaking <input checked="" type="checkbox"/> Listening	Application <input checked="" type="checkbox"/> Hands-on <input checked="" type="checkbox"/> Meaningful <input checked="" type="checkbox"/> Linked to objectives <input checked="" type="checkbox"/> Promotes engagement	Assessment <input checked="" type="checkbox"/> Individual <input checked="" type="checkbox"/> Group <input checked="" type="checkbox"/> Written <input type="checkbox"/> Oral					
Arizona Math Standards Addressed	<ul style="list-style-type: none"> • Not Applicable 						
Arizona Science Standards Addressed	<ul style="list-style-type: none"> • Not Applicable 						

Visual Test

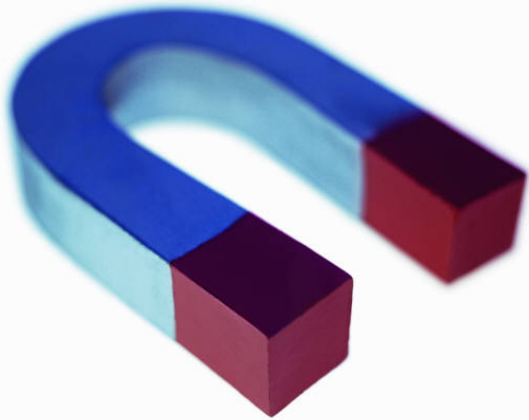
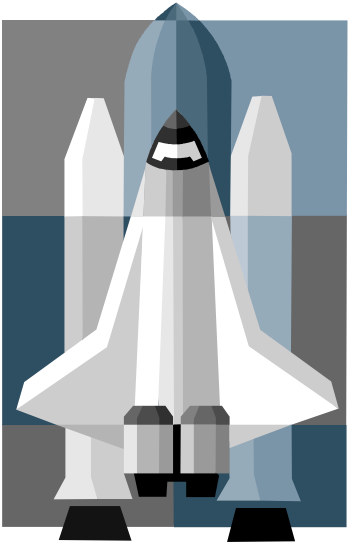
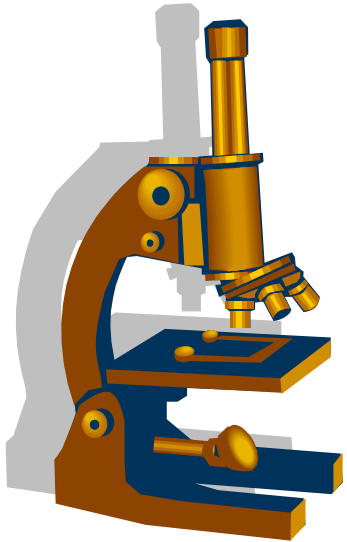
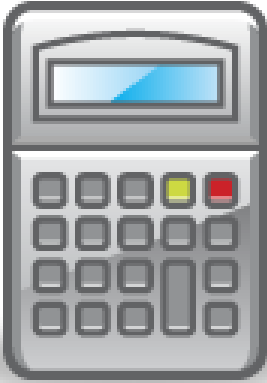



Sample Word List for Auditory Test

(or use your own words)

Arizona

Blue

Book

College

Computer

Engineering

Graduation

Math

Red

Scholarship

School

Science

Spaghetti

Star

Triangle

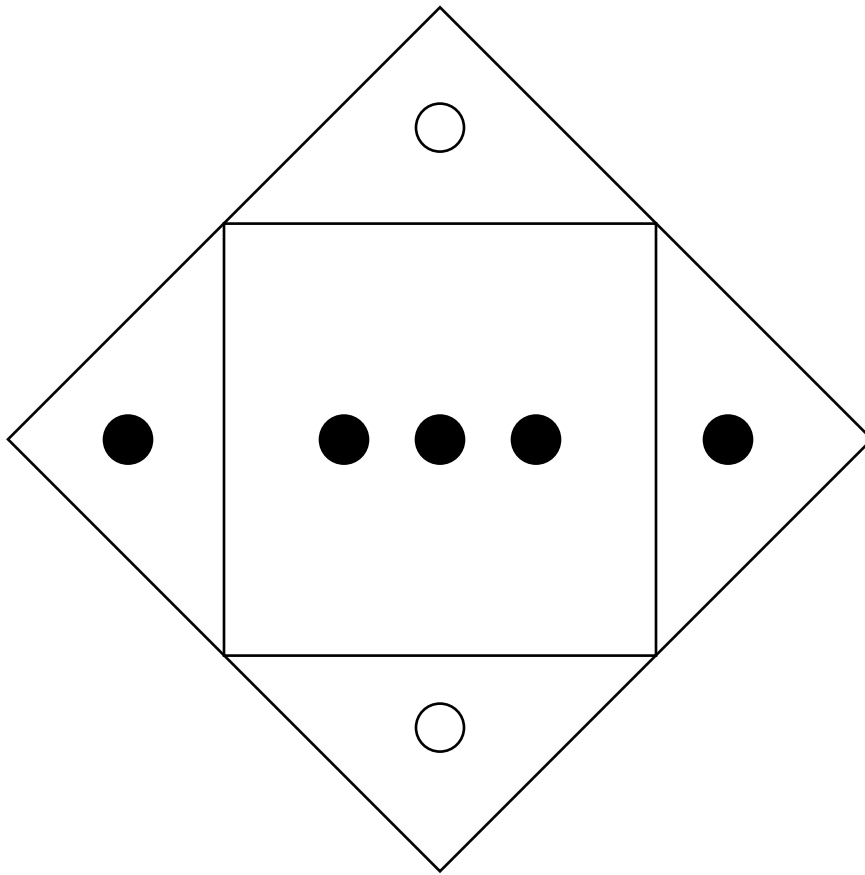



LEARNING STYLE INVENTORY

Read each statement carefully and consider how it applies to you. On the line next to each statement, write the number that indicates whether the statement

3 = always applies to you **2 = sometimes** applies to you **1 = never** applies to you

VISUAL

- _____ I enjoy doodling and even my notes have lots of pictures, arrows, etc. in them.
- _____ I remember something better if I write it down.
- _____ I get lost or am late if someone TELLS me how to get to a new place and I didn't write down the directions.
- _____ When trying to remember someone's telephone number, or something new like that, it helps me to get a picture of it in my head.
- _____ If I am taking a test, I can "see" the textbook page and where the answer is.
- _____ It helps me to LOOK at the person when listening. It keeps me focused.
- _____ I had speech therapy.
- _____ It's hard for me to understand what a person is saying when there are people talking or music playing.
- _____ It is better for me to get work done in a quiet place.

_____ **VISUAL TOTAL**

AUDITORY

- _____ My written work doesn't look neat to me. My papers have crossed-out words and erasures.
- _____ It helps to use my finger as a pointer when reading to keep my place.
- _____ Papers with very small print or blotchy dittos or poor copies are tough on me.
- _____ I understand how to do something if someone tells me rather than having to read the same thing to myself.
- _____ I remember things that I hear, rather than things that I see or read.
- _____ Writing is tiring. I press down too hard with my pen or pencil.
- _____ My eyes get tired fast, even though the eye doctor says my eyes are OK.
- _____ When I read, I mix up words that look alike, such as *them* and *then*, and *bad* and *dad*.
- _____ It's hard for me to read other people's handwriting.
- _____ If I had my choice to learn new information from a lecture or a textbook, I would choose to hear it rather than read it.

_____ **AUDITORY TOTAL**

KINESTHETIC

- _____ I don't like to read directions; I'd rather just start doing.
- _____ I learn best when I am shown how to do something, and I have the opportunity to do it.

- _____ Studying at a desk is not for me.
- _____ I tend to solve problems through a more trial and error approach, rather than using a step-by-step method.
- _____ Before I follow directions, it helps me to see someone else do the task first.
- _____ I find myself needing frequent breaks while studying.
- _____ I am not skilled in giving verbal explanations or directions.
- _____ I do not become easily lost, even in strange surroundings.
- _____ I think better when I have the freedom to move around.
- _____ When I can't think of a specific word, I'll use my hands a lot and call something a "what-cha-ma-call-it" or a "thing-a-ma-jig."

_____ **KINESTHETIC TOTAL**

Total your score for each section:

Visual = _____ **Auditory** = _____ **Kinesthetic** = _____

The area with the **highest total** indicates your primary learning style, or the way that you learn most effectively.

My **primary** learning style is _____.

Your **second highest total** indicates the area that supports your primary learning style.

My **secondary** learning style is _____.

You are not always just one type of learner.
Your learning style may vary over time and by situation.



20 Memory Techniques For More Productive Study Habits

Organize it.

Organized information is easier to find.

1. Learn from the general to the specific.

Skim for a general idea. Make sure and get the big picture before the little details.

2. Make it meaningful

When information helps you get something you want, it's easier to remember. That is one reason it pays to be specific about what you want.

3. Create associations.

When you are learning something new, learn it in a way that makes sense to you. You can remember it better if you store it near similar or related ideas.

Use your body.

Learning is an active process; get all your senses involved.

4. Learn it once, actively.

Be as active as possible. Move around when studying so that you don't get bored or fall asleep. Boredom puts memory to sleep. Wake up and learn!

5. Relax.

When we're relaxed, we absorb new information quicker and recall it with greater accuracy. Being relaxed does not mean being drowsy or asleep. It means free of nervousness and tension, which increases learning.

6. Create pictures.

Draw diagrams. Make cartoons. Use them to connect facts and illustrate relationships.

7. Recite and repeat.

When you repeat something out loud, you anchor the concept in two different senses, feeling and hearing. You can feel the words being spoken and you can hear them as you speak.

8. Write it down.

Writing things down helps you to remember an idea, even if you look at it once but if you continue to write the repetition will help you to master the idea.

Use your brain.

Work with your memory, not against it.

9. Reduce interference.

Find a place that is quiet and free from distraction.

10. Use daylight.

Many people can concentrate more effectively during the day.

11. Over learn.

Learn a subject until it becomes second nature. When you have mastered not only the required material but supporting material your confidence in the subject will increase and you will be better at it.

12. Escape the short-term memory trap.

Short-term memory can decay after a few minutes and rarely last more than a few hours. Instead do mini-reviews before a study session so that you can recall information during your study time.

13. Distribute learning.

Do not do long marathon runs of studying. You will learn more by breaking down your study time into shorter more productive sessions. Use breaks as mini-rewards from studying. But if you are on task and you are consumed by an idea don't stop you will learn more from your interest in the subject.

14. Be aware of attitudes.

People who believe that history is boring tend to have problems remembering historical facts. People who believe math is difficult; they have trouble recalling mathematical equations.

15. Choose what not to store in memory.

Be picky as to what you are remembering. Just think of what will be on a test and concentrate on learning those core concepts.

16. Combine memory techniques.

Choosing two or three of the above listed techniques will increase your chances of retention. Some techniques may work better in one subject than others. Try all different sorts of combination to be as productive as possible.

Recall it.

This is easier when you use the other principles to store information.

17. Remember something else.

When you are stuck and can't remember a particular fact remember something else that is related to the subject area. If you brainstorm what you do know the answer you are looking for is bound to come up.

18. Notice when you do remember.

Notice the way that you are remembering things. If you are remembering ideas that you have read then it is better for you to study by reading. Be honest with yourself and learn what's best for you.

19. Use it before you lose it.

Even information that you have stored in long term memory can be hard to remember when you don't recall it. So practice and recall speak it, read it, write it, and apply it. It will be easier way once it is natural to you.

20. And, remember, you never forget.

An idea never leaves your memory it is just up to you to believe it is there and find where it is stored...it will eventually come to you.



Learning How to Learn

Part 1: Information Processing System (IPS)

The IPS consists of three parts:

Short-Term Memory (STM) ► Working Memory (WM) ► Long-Term Memory (LTM)

All information is first inputted into the STM. From there the information is either lost or put into the WM. Once in WM the information can either be lost or retained for a limited period in the WM, or moved into the LTM.

Short-Term Memory – All information attained from the environment that can be sensed (seen, heard, or smelled) enters into the STM. However if this information is not attended to by the WM, then it is forgotten.

Working Memory – Information is stored for a small period of time (around 5 to 20 seconds) and can only hold five to nine chunks of information at one time or the “ 7 ± 2 Magic Number”. By chunking data, more is able to be stored in the WM at one time. **Maintenance rehearsal** is the repetition of an idea in order to store that information for longer than 20 seconds.

Long Term Memory – All information we have, but are not currently using are saved in the LTM. It is said that information is never forgotten, but rather becomes hard to retrieve or locate. In order to get information into the LTM, it must take time and effort. Having prior knowledge on a topic makes it easier to learn, since information is being added on. Reading the assignment before the lecture makes it easier to understand the information when presented in class.

There are two types of learning:

Rote learning – information is learned by repetition or rehearsal. This is helpful for learning lists, dates, or other basic knowledge.

Meaningful learning – the information is related to prior knowledge, making it easier to understand. The student tries to make sense of the information, helping them to understand complex issues.

Part 2: Learning Strategies

Different Learning Strategies promote the retention of different types of information. These consist of rehearsal, elaboration, and organizational strategies.

Rehearsal Strategies:

Reciting, repeating or practicing over and over information until it is remembered. Not helpful for learning complex information since it does not connect new information with information we already have in the LTM.

There are two types of rehearsal strategies:

- Distributed Practice
- Massed Practice

Distributed Practice is when the student uses short periods of studying to learn information. This method is more effective when the information is chunked into patterns that can be remembered.

Massed Practice is when the student tries to study a lot of information in a small amount of time, such as cramming for an exam the night before. This is a poor method of learning complex information or moving that information into the LTM, since few of the information is remembered after 24 hours.

Elaboration Strategies:

Uses mnemonic devices in order to connect present learning with past information

Two mnemonic systems used are acronyms and key-word method.

Acronyms – A mnemonic is formed by the first letter in each word.

Roy G. Biv

Red orange yellow green blue indigo violet

Key-Word Method – an image is created in the mind to associate or relate with another word.

After note taking in a lecture, students should note make. Go throughout their notes and write notes asking questions about or elaborating on the ideas that were presented in lecture.

Analogies are another method to learn more effectively. This method prior information is related to new information in order to better remember a concept.

Organizational Strategies:

Categorizing knowledge is a more effective way to remember information than trying to recall unorganized fragments. Organizing data makes it easier to retrieve that information later. Outlines can help to understand information in a text by categorizing that information into smaller ideas.

Information from: Dembo, Myron H., Motivation and Learning Strategies for College Success, 2000, Lawrence Erlbaum Associates, Publishers, Mahwah, NJ

TRAITS OF LEARNING STYLES

VISUAL LEARNER

I SEE

Visual Learners learn best through *seeing*, using their eyes as the primary way to learn. These learners:

- Desire to see words written down;
- Enjoy a picture of something being described;
- Prefer a time line to remember historical events;
- Prefer written instructions for assignments;
- Observe all the physical elements in a classroom;
- Carefully organize their learning materials;
- Enjoy decorating learning areas;
- Desire photography and illustrations with printed content;
- Remember and understand through the use of diagrams, charts, maps;
- Appreciate presentations using overhead cells or handouts;
- Study material by reading over notes and organizing in outline form;
- Enjoy visual art activities.

AUDITORY LEARNER

I HEAR

Auditory Learners learn best through *hearing*, using their ears and their voices as the primary way to learn. These learners:

- Remember what they hear and their own verbal expressions;
- Remember by talking aloud and through verbal repetition;
- Desire to talk through a concept not understood;
- Verbally express excitement about learning;
- Can remember verbal instructions without recording them;
- Enjoy class discussions and talking with others;
- Are easily distracted by sound but also find silence distracting;
- Enjoy interesting lectures;
- Find it difficult to work quietly for extended periods of time;
- Enjoy music activities.

KINESTHETIC LEARNER

I DO

Kinesthetic Learners learn best through *touch*, using their hands as the primary way to learn. These learners:

- Become physically involved in the subject being studied;
- Enjoy acting out a situation through dramatic methods;
- Enjoy making a product or completing a project;
- Prefer building and physically handling learning materials;
- Remember and understand through doing something;
- Take study notes to keep busy but often do not read them;
- Enjoy using computers
- Physically express enthusiasm by getting active and excited;
- Find it difficult to sit still for extended periods of time;
- Enjoy hands-on art activities.

Study Strategies for the Three Learning Modes

THE SKILLS	VISUAL LEARNER <i>Learn the best by seeing</i>	AUDITORY LEARNER <i>Learn the best by hearing</i>	KINESTHETIC LEARNER <i>Learn the best by: -moving physically -participative experiences</i>
NOTE TAKING	<ol style="list-style-type: none"> 1) Sit in front of room. 2) Use pictures & symbols and visual maps in your notes. 3) Ask for graphs & drawings to help remember main concepts. 4) Request written instructions. 5) Reword notes into charts and graphs. 	<ol style="list-style-type: none"> 1) Sit close to the speaker. 2) Repeat important points quietly. 3) Listen for specifics. Don't let note taking interfere with listening. 4) Listen for key words. 5) Tape record lecture. Listen to tape & update notes immediately after class. 	<ol style="list-style-type: none"> 1) Move to remember! During lecture tap foot, move head, write, stand up (if allowed). 2) Volunteer: answer questions, participate in discussions. 3) Take copious notes. Move to remember! 4) Recopy notes and vocabulary.
READING	<ol style="list-style-type: none"> 1) Survey by looking at visual aids (pictures, graphs, & charts before you start to read a chapter). 2) As you read make a visual map of key headings and concepts. 3) Make charts and schematics of difficult concepts. 	<ol style="list-style-type: none"> 1) Survey by reading chapter headings and asking survey questions out loud. 2) Try reading difficult sections out loud. 3) Summarize out loud immediately after reading a paragraph or section. 	<ol style="list-style-type: none"> 1) Survey by writing preview questions and answers. Write as you review. 2) Use workbooks and computers to learn material whenever possible. 3) Try to write a summary immediately after reading a difficult paragraph or section.
TAKING TESTS	<ol style="list-style-type: none"> 1) Request written instructions. 	<ol style="list-style-type: none"> 1) Request that instructions be read out loud. 2) Repeat instructions (quietly) to yourself. Note: It is wise to check this out ahead of time with your instructor. 	<ol style="list-style-type: none"> 1) Position yourself where you have plenty of room to move. 2) To avoid recall during exam try: <ol style="list-style-type: none"> a. Moving in your chair. b. Feel yourself doing a lab procedure or other experience that is relevant to the question.
EXAM PREP.	<ol style="list-style-type: none"> 1) Use visual images to remember main points. 2) Use flash cards. 3) Use visual maps to help you understand & remember difficult concepts 4) Use pictures and symbols in your text for emphasis & memory. 5) Look at soothing works of art to relax your mind during study breaks 6) Check library for films & visual aids pertaining to your subject matter. 	<ol style="list-style-type: none"> 1) Read important material from notes or reading out loud. 2) Record and listen to vocabulary for each day's lesson. 3) Talk about what you have learned. Participate in study groups. Give oral presentations. 4) Use slow Baroque Music to enhance your concentration while studying. 5) Use special Relaxation Music for period study breaks. 	<ol style="list-style-type: none"> 1) Memorize key words & concepts using finger spelling 2) Seek experiences that will teach you main concepts: labs, discussions, field work, etc. 3) Use equipment, tools, models, etc. of a subject as much as possible. 4) Try moving about while memorizing material: walk, use arms gestures, etc. 5) Use physical exercises for study breaks. 6) Seek on the job training, work study, field work, lab work, and cooperative learning experiences to become physically involved in your area of study.

Week	6 and 7
Sequence of Activities	<p>Week 6</p> <ul style="list-style-type: none"> • Math Puzzle: Climbing Snail (10 minutes) • Spaghetti Beam Bridge (50-70 minutes) <p>Week 7</p> <ul style="list-style-type: none"> • Math Puzzle: Horse Trade (10 minutes) • Spaghetti Beam Bridge (50-70 minutes)
Duration	60-80 minutes each meeting
Age Level	Middle School
Essential Question	How do engineering elements such as trusses address compression force and tension force on a bridge and how do they improve the strength and stability of a bridge?
Learning Objectives	<p>Math Puzzle</p> <ul style="list-style-type: none"> • TSW solve a logical mathematical word problem using grade appropriate problem solving strategies • TSW solve a multi-step word problem by applying various numerical operations <p>Spaghetti Bridge</p> <ul style="list-style-type: none"> • TSW identify and recognize the 3 types of bridges: beam, arch, and suspension • TSW describe the design features that classify the 3 types of bridges • TSW define and apply the following terms: compression, tension, dissipate force, and transfer force • TSW design and construct a spaghetti beam bridge using given materials • TSW devise a spaghetti beam bridge design concept with their partner • TSW modify their design as they begin to build to improve the overall structure • TSW evaluate the strengths and weaknesses of their design and their constructed bridge • TSW compare their design concept and their constructed bridge to those of their peers • TSW describe the process they took to complete the spaghetti bridge project • TSW explain how compression and tension is acting on their spaghetti beam bridge
Other Objectives	<ul style="list-style-type: none"> • TSW develop a working plan with their group to develop a cooperative environment • TSW communicate with their group by contributing their vocal input • TSW listen as their peers discuss the design of their investigation • TSW write down the procedure they used to design their project
Key Terms	<ul style="list-style-type: none"> • Beam Bridge • Arch Bridge • Abutment: the end support of a bridge, in a arch bridge, the lower part of the arch that supports the arch. • Suspension Bridge • Trusses • Compression: a force that acts to compress or shorten the thing it is acting on. • Tension: a force that acts to expand or lengthen the thing it is acting on. • Dissipate force: to spread force out over a greater area, so that no one spot has to bear the brunt of the concentrated force. An arch bridge is a good example of dissipation • Transfer force: to move force from an area of weakness to an area of strength, an area designed to handle the force. A suspension bridge is a good example of transference.

<p>Materials Needed</p>	<p>Math Puzzle Week 6:</p> <ul style="list-style-type: none"> • Climbing Snail <p>Spaghetti Beam Bridge Week 6 For Teacher Demonstration</p> <ul style="list-style-type: none"> • 2 chairs or 2 tables pulled close enough for the meter stick to span • Meter stick <p>Per student</p> <ul style="list-style-type: none"> • Bridge Handout • MESA Notebook handout <p>Per Team (2-3 students)</p> <ul style="list-style-type: none"> • Spaghetti Beam Bridge Challenge handout • Drawing paper • ½ pound of spaghetti • Glue <p>Math Puzzle Week 7</p> <ul style="list-style-type: none"> • Horse Trade <p>Spaghetti Beam Bridge Week 7 Per group</p> <ul style="list-style-type: none"> • Scale- Triple beam or Digital • Stopwatch <p>Per student</p> <ul style="list-style-type: none"> • MESA Notebook handout <p>Per Team (2-3 students)</p> <ul style="list-style-type: none"> • Glue for repairs • 4 textbooks to suspend bridge across • 1 kg weight • Spaghetti Beam Bridge Challenge handout • My Bridge Design handout • Spaghetti Bridge Competition Data Sheet •
<p>Week 6</p>	<p>Week 6: Math Puzzle</p> <ol style="list-style-type: none"> 10. Pass math problem out to students as they arrive for MESA meeting. Remind them to sign in on attendance sheet. 11. Inform students they may work in pairs to solve the puzzle. 12. After 5 minutes, discuss problem and have 1 student model possible solution on the board. Discuss process of problem solving with class and ask for other ways to solve the problem. 13. Collect MESA Notebook handout from previous meeting and discuss. Students may wish to share their sketches. Discuss conclusion question. <p>Week 6 Spaghetti Beam Bridge</p> <ol style="list-style-type: none"> 1. Teacher will pass out Bridge handout. 2. Teacher will explain and give examples of the 3 types of bridges. Teacher may use various sources to show examples: Bridge handout, overhead, internet, etc... Discuss positive and negative factors for each type of bridge. <div style="border: 1px solid black; padding: 10px; margin-top: 10px;"> <p><i>For example:</i> <u>Beam Bridge:</u> simple design, probably inexpensive, trusses can be added above or below the bridge to add support and strength, can only be built over short distances. <u>Arch Bridge:</u> very strong design, strength comes from design that dissipates tension force to the abutments, old arch bridges from Roman times are still being used, can be built over longer distances that beam bridges including over water <u>Suspension Bridge:</u> can span very long distances, strength of design comes from the suspension design, the towers and the anchorages of a suspension bridge absorb all of the compression pressure, tension is relieved by cables suspended between the towers and the anchors, can span water, could be very expensive.</p> </div>

3. Teacher will pass out MESA Notebook Handout
4. Write the key terms on the board.

Teacher Demonstration:

Take a meter stick and span it across 2 tables or 2 chairs - you have just created a crude beam bridge. Now, place a weight in the middle of the meter stick or put pressure on it. Notice how the meter stick bends. The top side is under compression and the bottom side is under tension. If you keep adding weight, eventually the meter stick will break. Actually, the top side will buckle and the bottom side will snap.
 Note: Any similar demonstration will work, you could use simpler objects.

5. Discuss meaning of each term and come up with a simple student definition that the class and you agree on. Write the student definition on the board. Have students copy the student definition into their MESA Notebook handout.
6. Tell students they will be constructing a beam bridge using spaghetti and glue.
7. Pass out Spaghetti Beam Bridge Challenge handout. Read and discuss instructions with students.
8. Have students get in groups of 3 and pass out drawing paper and tell students to get out a pencil.
9. Give them 5 minutes to design their bridge on paper. Monitor students and occasionally ask, "How will your bridge look? Are you going to implement a truss design? Where is the compression going to be on your bridge? Where is the tension going to be? How can you lessen or spread out the compression and tension forces?"
10. After 5 minutes, pass out spaghetti and glue to each group.
11. Tell them they have 30-40 minutes to create their bridge. They must work together to complete it in time.
12. Monitor students to check for participation and understanding.
13. When time is up, have students carefully take their bridges to an area in your room where they will dry completely and store safely until the next meeting.
14. Have students clean up supplies.
15. Collect Spaghetti Beam Bridge Challenge handout and MESA Notebook handout from students and keep until next week.

Week 7

Week 7: Math Puzzle

1. Pass math problem out to students as they arrive for MESA meeting. Remind them to sign in on attendance sheet.
2. Inform students they may work in pairs to solve the puzzle.
3. After 5 minutes, discuss problem and have 1 student model possible solution on the board. Discuss process of problem solving with class and ask for other ways to solve the problem.

Week 7 Spaghetti Beam Bridge

1. Tell students to get their bridge and check for repairs that need to be done. Allow them 5-10 minutes to re-glue any parts that may have fallen off.

Note: Inform students not to use too much glue. It will take longer to dry and it may not dry by the time group is ready to test.

2. While students are making repairs, pass out Spaghetti Beam Bridge Challenge handout and MESA Notebook handout.
3. After time is up, gather student focus back on you.
4. Review Spaghetti Beam Bridge Challenge handout. Discuss challenge specifications.
5. Ask teams to present their design drawing to their peers. Give them 5 minutes to prepare for this mini presentation. Pass out the My Bridge Design handout or write the following components on the board that they need to cover:
 - How did you come up with your design?
 - Did you have to modify your design when you began to build your bridge? Why? How did you modify it?

	<ul style="list-style-type: none"> • Did you use trusses? If so, how is it strengthening your bridge? • Describe where compression forces are acting on your bridge. • Describe where tension forces are acting on your bridge. • What problems did you encounter in making your bridge? • What would you change about your bridge design if you were to do this again? <ol style="list-style-type: none"> 6. Each team will do a brief presentation of their bridge addressing the above mentioned components. 7. Pass out Spaghetti Bridge Competition Data Sheet handout to each team. 8. Have students fill in Team Names of each team. See sample for example. 9. Teams will bring their bridges up to teacher to be weighed. Have each team record the mass of ALL the team's bridges in the space provided on the handout. Teacher can also write the mass of each team's bridge on the board. <div style="border: 1px solid black; padding: 5px; margin: 10px 0;"> <p><i>While all masses of bridges are found, have other teams get 4 textbooks out. Their bridge will span across the textbooks during the competition.</i></p> </div> <ol style="list-style-type: none"> 10. Have students lay their bridge across the textbooks. Use a stopwatch to time the event. 11. At the set start time, students will place the 1kg weight on their bridge. Remind students that their bridge should try to hold the weight for 10 minutes. 12. The students may keep watch over their bridge or they may wander to other teams to check out their design and construction. 13. As bridges break, note the time and have the teams record it on their Spaghetti Bridge Competition Data Sheet handout. 14. At the conclusion of 10 minutes, the bridges that remain will be noted. 15. The team with the most efficient bridge will be the team whose bridge held the 1kg weight for 10 minutes with the least amount of supplies (the bridge that weighed the least).
Closure	<ol style="list-style-type: none"> 1. Discuss the design elements of bridges that lasted 10 minutes. What did they have in common? 2. Discuss the activity with the students. Address questions and guide students to reflect on how they could make their bridge better. 3. Have students complete the 'procedure' section of their MESA Notebook handout. 4. Write the following 'conclusion' question on the board and have students answer: <i>How do engineering elements such as trusses address compression force and tension force on a bridge and how do they improve the strength and stability of a bridge?</i> <p><i>*Note: Students may complete the 'Procedure' and 'Conclusion' section of the MESA Diary at home before the next MESA meeting if time is an issue.</i></p> <ol style="list-style-type: none"> 5. Clean up and collect their handouts.
Informal Assessment	<ul style="list-style-type: none"> • Monitor students to check for understanding • Monitor students to check for participation • Student oral presentation explaining their team's procedure
Formal Assessment	<ul style="list-style-type: none"> • Completed Bridge Design • Completed Bridge • Completed MESA Notebook handout
Trouble Shooting	<ul style="list-style-type: none"> • Keep an eye on the time. Don't linger too long over a single component or you will run out of time. • Have handouts printed before meetings. • Review bridge handout • Have demonstration materials ready before meeting • Keep an eye on the glue when students are constructing • Have extra glue handy • Keep completed bridges in a safe place between meetings

	<ul style="list-style-type: none"> • If using a trip-beam, make sure it is balanced before weighing bridges. If you are using a digital scale, reset it before weighing the next bridge. • Have plenty of 1kg weights for students to use. You can use anything as a weight, as long as they all weigh around 1 kg and all weigh the same. Ex. Textbooks 						
<p>SEI Strategies Used</p> <table border="0" style="width: 100%;"> <tr> <td style="vertical-align: top; width: 33%;"> <p>Preparation</p> <input type="checkbox"/> Adaptation of Content <input type="checkbox"/> Links to Background <input type="checkbox"/> Links to Past Learning <input checked="" type="checkbox"/> Strategies incorporated </td> <td style="vertical-align: top; width: 33%;"> <p>Scaffolding</p> <input type="checkbox"/> Modeling <input checked="" type="checkbox"/> Guided practice <input type="checkbox"/> Independent practice <input type="checkbox"/> Comprehensible input </td> <td style="vertical-align: top; width: 33%;"> <p>Grouping Options</p> <input type="checkbox"/> Whole class <input checked="" type="checkbox"/> Small groups <input type="checkbox"/> Partners <input type="checkbox"/> Independent </td> </tr> <tr> <td style="vertical-align: top;"> <p>Integration of Processes</p> <input checked="" type="checkbox"/> Reading <input checked="" type="checkbox"/> Writing <input checked="" type="checkbox"/> Speaking <input checked="" type="checkbox"/> Listening </td> <td style="vertical-align: top;"> <p>Application</p> <input checked="" type="checkbox"/> Hands-on <input checked="" type="checkbox"/> Meaningful <input checked="" type="checkbox"/> Linked to objectives <input checked="" type="checkbox"/> Promotes engagement </td> <td style="vertical-align: top;"> <p>Assessment</p> <input type="checkbox"/> Individual <input checked="" type="checkbox"/> Group <input checked="" type="checkbox"/> Written <input checked="" type="checkbox"/> Oral </td> </tr> </table>		<p>Preparation</p> <input type="checkbox"/> Adaptation of Content <input type="checkbox"/> Links to Background <input type="checkbox"/> Links to Past Learning <input checked="" type="checkbox"/> Strategies incorporated	<p>Scaffolding</p> <input type="checkbox"/> Modeling <input checked="" type="checkbox"/> Guided practice <input type="checkbox"/> Independent practice <input type="checkbox"/> Comprehensible input	<p>Grouping Options</p> <input type="checkbox"/> Whole class <input checked="" type="checkbox"/> Small groups <input type="checkbox"/> Partners <input type="checkbox"/> Independent	<p>Integration of Processes</p> <input checked="" type="checkbox"/> Reading <input checked="" type="checkbox"/> Writing <input checked="" type="checkbox"/> Speaking <input checked="" type="checkbox"/> Listening	<p>Application</p> <input checked="" type="checkbox"/> Hands-on <input checked="" type="checkbox"/> Meaningful <input checked="" type="checkbox"/> Linked to objectives <input checked="" type="checkbox"/> Promotes engagement	<p>Assessment</p> <input type="checkbox"/> Individual <input checked="" type="checkbox"/> Group <input checked="" type="checkbox"/> Written <input checked="" type="checkbox"/> Oral
<p>Preparation</p> <input type="checkbox"/> Adaptation of Content <input type="checkbox"/> Links to Background <input type="checkbox"/> Links to Past Learning <input checked="" type="checkbox"/> Strategies incorporated	<p>Scaffolding</p> <input type="checkbox"/> Modeling <input checked="" type="checkbox"/> Guided practice <input type="checkbox"/> Independent practice <input type="checkbox"/> Comprehensible input	<p>Grouping Options</p> <input type="checkbox"/> Whole class <input checked="" type="checkbox"/> Small groups <input type="checkbox"/> Partners <input type="checkbox"/> Independent					
<p>Integration of Processes</p> <input checked="" type="checkbox"/> Reading <input checked="" type="checkbox"/> Writing <input checked="" type="checkbox"/> Speaking <input checked="" type="checkbox"/> Listening	<p>Application</p> <input checked="" type="checkbox"/> Hands-on <input checked="" type="checkbox"/> Meaningful <input checked="" type="checkbox"/> Linked to objectives <input checked="" type="checkbox"/> Promotes engagement	<p>Assessment</p> <input type="checkbox"/> Individual <input checked="" type="checkbox"/> Group <input checked="" type="checkbox"/> Written <input checked="" type="checkbox"/> Oral					
<p>Arizona Math Standards Addressed</p>	<ul style="list-style-type: none"> • S1C2: TSW understand and apply numerical operations such as solving grade level appropriate word problems using appropriate operations and numbers 						
<p>Arizona Science Standards Addressed</p>	<ul style="list-style-type: none"> • S1C1: TSW formulate predictions and questions based on observations • S1C2: TSW design and conduct an investigation demonstrating safe behavior and appropriate procedures while keeping a record of observations, notes, sketches, and questions • S1C4: TSW communicate the results of their investigation • S5C2: TSW understand the relationship between force and motion 						

Climbing Snail

A snail is at the bottom of a 20 meters deep pit. Every day the snail climbs 5 meters upward, but at night it slides 4 meters back downwards.

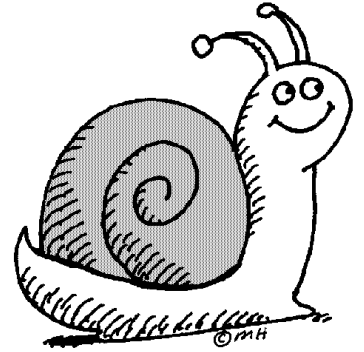

The Question: How many days does it take before the snail reaches the top of the pit?

Horse Trade

A man decides to buy a nice horse. He pays \$60 for it, and he is very content with this strong animal. After a year, the value of the horse has increased to \$70 and he decides to sell the horse. But, already a few days later, he regrets his decision to sell the beautiful horse and he buys it back. Unfortunately, he has to pay \$80 to get it back, so he loses \$10. After another year of owning the horse, he finally decides to sell the horse for \$90.



The Question: What is the overall profit the man makes?

Climbing Snail

A snail is at the bottom of a 20 meters deep pit. Every day the snail climbs 5 meters upward, but at night it slides 4 meters back downwards.

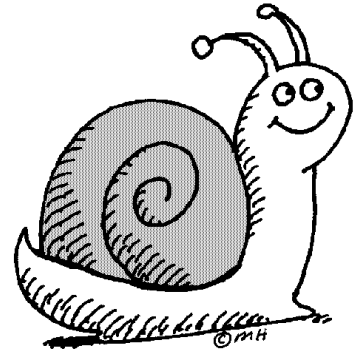

The Question: How many days does it take before the snail reaches the top of the pit?

On the first day, the snail reaches a height of 5 meters and slides down 4 meters at night, and thus ends at a height of 1 meter.

On the second day, he reaches 6 meters, but slides back to 2 meters.

On the third day, he reaches 7 meters, but slides back to 3 meters.

...

On the fifteenth day, he reaches 19 meters, but slides back to 15 meters.

On the sixteenth day, he reaches 20 meters, so *now* he is at the top of the pit!

Conclusion: The snail reaches the top of the pit on the 16th day!...

Horse Trade

A man decides to buy a nice horse. He pays \$60 for it, and he is very content with this strong animal. After a year, the value of the horse has increased to \$70 and he decides to sell the horse. But, already a few days later, he regrets his decision to sell the beautiful horse and he buys it back. Unfortunately, he has to pay \$80 to get it back, so he loses \$10. After another year of owning the horse, he finally decides to sell the horse for \$90.

The Question: What is the overall profit the man makes?

Consider the trade-story as if it describes two separate trades, where:

In the first trade, the man buys something for \$60 and sells it again for \$70, so he makes a profit of \$10.

In the second trade, the man buys something for \$80 and sells it again for \$90, so he makes again a profit of \$10.

Conclusion: The man makes an overall profit of $\$10 + \$10 = \$20$.

You can also look at the problem as follows: the total expenses are $\$60 + \$80 = \$140$ and the total earnings are $\$70 + \$90 = \$160$. The overall profit is therefore $\$160 - \$140 = \$20$.

The Beam Bridge

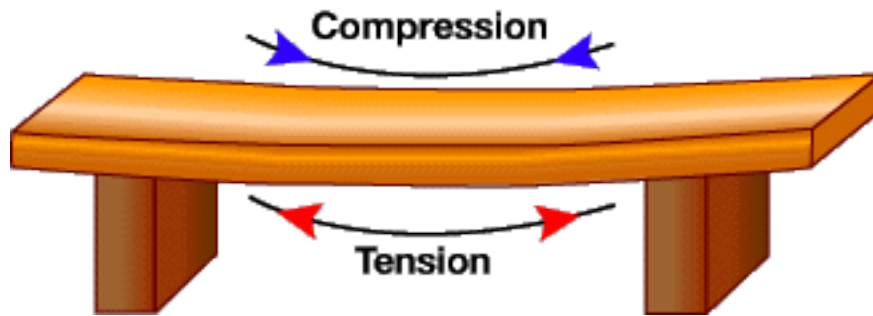

A beam bridge is basically a rigid horizontal structure that is resting on two piers, one at each end. The weight of the bridge and any traffic on it is directly supported by the piers. The weight is traveling directly downward.

Compression

The force of compression manifests itself on the top side of the beam bridge's deck (or roadway). This causes the upper portion of the deck to shorten.

Tension

The result of the compression on the upper portion of the deck causes tension in the lower portion of the deck. This tension causes the lower portion of the beam to lengthen.



Beam Bridge in Battleground Creek Bridge in Texas



Beam bridge with trusses in Venango County, Pennsylvania

Trusses

What is a truss? A truss is a type of framework, usually comprising straight struts and ties, which is designed to be stiff, even if all the joints are considered to be pinned. The design of a truss, which is usually a variant of a triangle, creates both a very rigid structure and one that transfers the load from a single point to a considerably wider area.



Corrugated cardboard is a good example of how a truss design makes the overall structure stronger.

Types of Bridge Trusses:

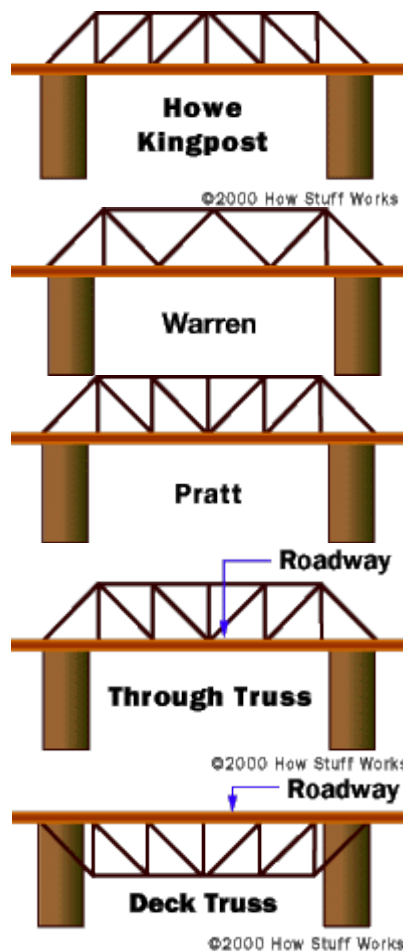

The Arch Bridge

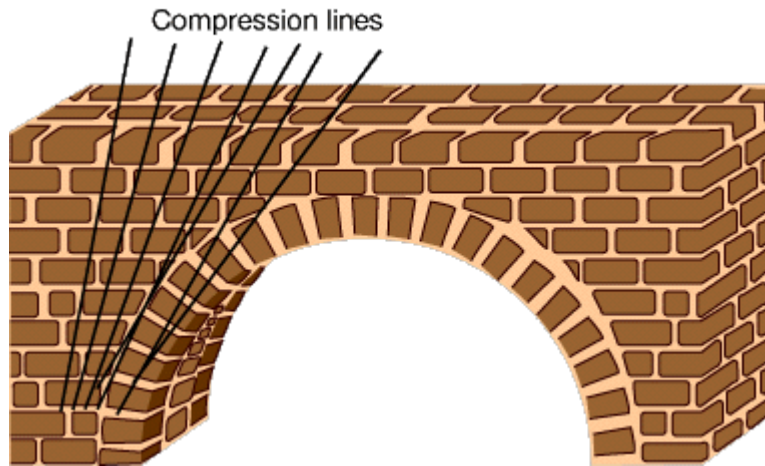

An arch bridge is a semicircular structure with abutments on each end. The design of the arch, the semicircle, naturally diverts the weight from the bridge deck to the abutments.

Compression

Arch bridges are always under compression. The force of compression is pushed outward along the curve of the arch toward the abutments.

Tension

The tension in an arch is negligible. The natural curve of the arch and its ability to dissipate the force outward greatly reduces the effects of tension on the underside of the arch. The greater the degree of curvature (the larger the semicircle of the arch), however, the greater the effects of tension on the underside.

As we just mentioned, the shape of the arch itself is all that is needed to effectively dissipate the weight from the center of the deck to the abutments. As with the beam bridge, the limits of size will eventually overtake the natural strength of the arch.

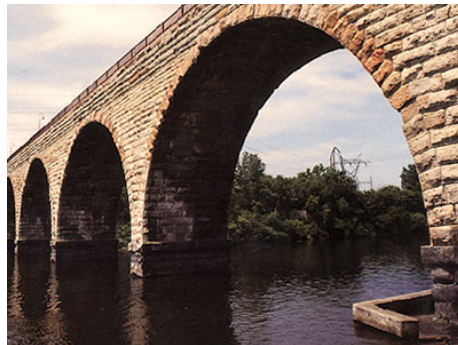

An Arch Bridge in Minnesota



An Arch Bridge in Clements, Kansas

The Suspension Bridge

A suspension bridge is one where cables (or ropes or chains) are strung across the river (or whatever the obstacle happens to be) and the deck is suspended from these cables. Modern suspension bridges have two tall towers through which the cables are strung. Thus, the towers are supporting the majority of the roadway's weight.

Compression

The force of compression pushes down on the suspension bridge's deck, but because it is a suspended roadway, the cables transfer the compression to the towers, which dissipate the compression directly into the earth where they are firmly entrenched.

Tension

The supporting cables, running between the two anchorages, are the lucky recipients of the tension forces. The cables are literally stretched from the weight of the bridge and its traffic as they run from anchorage to anchorage. The anchorages are also under tension, but since they, like the towers, are held firmly to the earth, the tension they experience is dissipated.

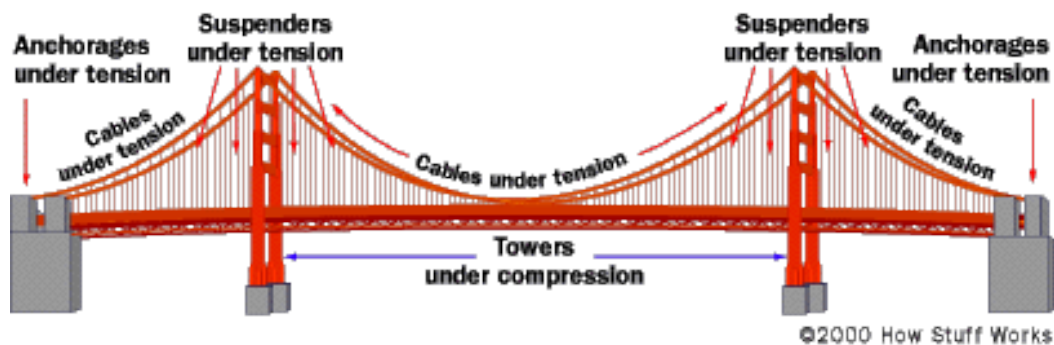
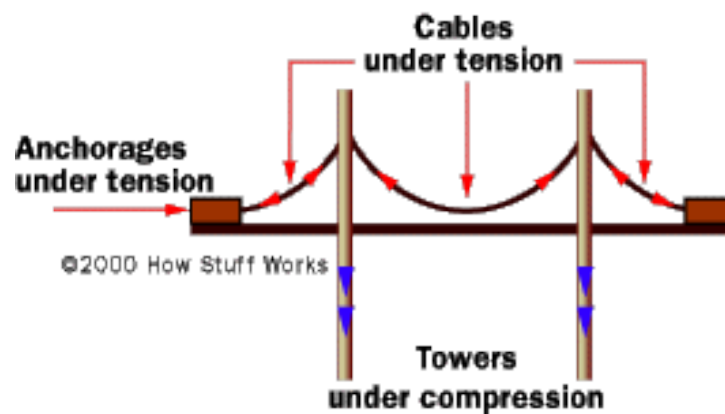

Almost all suspension bridges have, in addition to the cables, a supporting truss system beneath the bridge deck (a deck truss). This helps to stiffen the deck and reduce the tendency of the roadway to sway and ripple.

Types of Suspension Bridges

Suspension bridges come in two different designs: the suspension bridge, recognized by the elongated 'M' shape, and the less-common cable-stayed design, which has more of an 'A' shape. The cable-stayed bridge does not require two towers and four anchorages as does the suspension bridge. Instead, the cables are run from the roadway up to a single tower where they are secured.



'A' Shape Bridge in Savannah, Georgia



'M' Shape Bridge in New York City



'M' Shape Clifton Suspension Bridge

Spaghetti Beam Bridge Challenge

Goal:

Your team will design and construct a beam bridge out of spaghetti and glue that will hold 1kg of weight for a minimum of 10 minutes.

The competition component is for teams to design and build a bridge that uses the least amount of supplies. The bridge that holds 1kg of weight for 10 minutes and has used the least amount of spaghetti and glue wins.

The bridge must weigh less than 200 g and be at least 50 cm long.

Team Materials:

- Drawing paper
- 200 g (½ pound) of spaghetti
- Glue

You do not have to use all your materials, but you cannot share them with another group.

Instructions:

1. Read Spaghetti Beam Bridge Challenge.
2. Get drawing paper from teacher. With your team, come up with a design sketch for your bridge. On your sketch, note where compression forces and tension forces are acting.
3. Once your teacher approves your sketch, get spaghetti and glue.
4. You have 30-40 minutes to construct your bridge
5. Put your bridge in the space designated by your advisor.
6. Clean up.



My Bridge Design Team Oral Presentation

Your team has designed and constructed a beam bridge out of spaghetti and glue. You achieved this goal in 2 steps:

- Designed a bridge on paper
- Built your bridge according to the design

Your bridge had to address compression forces and tension forces. You labeled how these forces are acting on your bridge on your drawing.

Goal:

Your team will give a brief explanation of your bridge design drawing. In your brief presentation, please address the following components:

- How did you come up with your design?
- Did you have to modify your design when you began to build your bridge? Why? How did you modify it?
- Did you use trusses? If so, how is it strengthening your bridge?
- Describe where compression forces are acting on your bridge.
- Describe where tension forces are acting on your bridge.
- What problems did you encounter in making your bridge?
- What would you change about your bridge design if you were to do this again?

You have 5 minutes to plan your brief oral presentation.



Spaghetti Bridge Competition Data Sheet

Directions:

Write the names of all the teams in the MESA group. Record the mass of each team’s bridge. Once the competition begins, write down the time it took before the bridge collapsed under the 1kg weight. If a bridge holds for 10 minutes, write 10 minutes under time. Good Luck!

Team	Mass of Bridge in Grams	Time